



SPECIALTY FLUID FITTINGS & ACCESSORIES CATALOG

For Lubrication Systems
Catalog B151

Contents

Page.....	4	Page.....	14	Page.....	24-25
Quick disconnect couplings		90 degree tubing adapter body		PDI & SLR hose & assemblies	
Page.....	5	Page.....	15	Page.....	26-27
90 Deg Elbow Couplings		Banjo tubing adapter assembly		Dualine, Injector & Progressive	
Bulkhead Couplings		Banjo tubing adapter body		Low, Med. & High pressure hose assemblies	
Straight Connectors		Female branch tee tubing assembly		Barrel pump & Specialty hose assemblies	
Tee Couplings		Tee tubing adapter		Page.....	28-29
Page.....	6	Tee tubing adapter assembly		Hose	
90 Deg Elbow Connectors		Page.....	16	JIC adapters & 90 deg elbows	
90 Deg Adapters		Straight quick connect tubing adpt assy		Reusable JIC hose fittings	
Straight Couplings		Tee male branch quick connect tubing assy		JIC straight & tee adapters	
Page.....	7	Page.....	17	Page.....	30-31
30, 45 & 60 degree elbow connectors		90 degree quick connect tubing adpt assy		Straight male swivels	
Female branch tee connectors		Banjo quick connect tubing assembly		Grease fittings	
Male branch tee connectors		Straight quick connect tubing assembly		Tubing Clips	
Male run tee connectors		Tee quick connect coupling assembly		Page.....	32
Swivel fittings		Quick Connect Expander		Plastic tubing	
Page.....	8	Page.....	18	Spring cover	
Close, hex & hex reducing nipples		High Pressure quick connect fittings		Wire braid cover	
Reducing bushings		Page.....	19	Page.....	33
Page.....	9	Hex & closure plugs		Metal tubing	
Straight adapters		Drill bushings		Spiral wrap	
Page.....	10	Page.....	20	Split loom	
Straight tubing adapter assemblies-male		Female compression nuts		Page.....	34-35
Page.....	11	Male compression bushings		Check valves	
90 degree tubing adapter assemblies -male		Page.....	21	Pressure relief valves	
Page.....	12	Compression sleeves		Page.....	36-39
90 degree tubing adapter assemblies		Tubing inserts		Meter units	
Straight tubing adapter assemblies -female		Female caps		Page.....	40-43
Straight tubing coupling adapter body		Page.....	22	Control units	
Straight tubing coupling assemblies		Copper seals		Page.....	44
Page.....	13	Page.....	22	PVB/PVBM fittings	
90 degree elbow adapter body				Chokes	
straight tubing adapter body				Lube Point Monitor	

Notes:

Item part numbers in BLUE are non-stock. Check with customer service for lead times. Photos/Drawings are representative of their product groups.

Contents

Page..... 45	Page..... 61	Page..... 75
Pneumatic Electric Solenoid Valves	Anchor Blocks	Inline Filters
Page..... 46	Anchor Tees	Fill Strainers
Electric Zone Valves	Page..... 62-63	Stainless Inline Filter
Page..... 47	Shut-off Needle Valves	Page..... 76-77
Electric Shut Off Valves	Adjustable Flow Restrictor	Air Vents
Timers	Drain Valves	Liquid Tight Fittings
Page..... 48	Indicator Caps	Ball Valves
Controllers	Brushes	Breather Vent Valves
Page..... 49	Page..... 64	Muffler Filters
Switches	Pressure Switches - Wire Leads	Vent Valves
Page..... 50	Pressure Switches - DIN Style	Deutsch Wire Assemblies
Junction Headers	Pressure Switches - Spade Type	Page..... 78
Page..... 51	Page..... 65	DIN Connectors
Junction Blocks	Pressure Switches - DIN Style	DIN Wire Assemblies
Page..... 52	Pressure Switches - Spade Type	Electric Cables
Junctions	Pressure Switches - Digital	Page..... 79
Page..... 53	Page..... 66	M12 Connectors
Special Junctions	Pressure Switches - NEMA 3	M12 Cables
Junction Bars - 1/8NPT	Pressure Switches - NEMA 4X	Bayonet Connectors
Page..... 54	Page..... 67	Page..... 80
Junction Bars - 5/16-24	Pressure Switches - NEMA 4/4X	Filter Regulators
Page..... 55	Pressure Switches - Open Frame Type	FRL's
Junction Bars - M10X1	Page..... 68	Page..... 81
Page..... 56	Pressure Switches - XP - Explosion Proof	Regulators
Junction Bars - M8X1	Page..... 69	Air Control Panels
Junction Bars - Double - 5/16-24	Pressure Switches - Air	Horns
Page..... 57	Page..... 70-71	Apendix..... 82-93
Quick Connect Junctions	Pressure Gauges	SLR Layout Compression
Page..... 58-59	Oil Level Sight Plugs	SLR Layout Continious
ZEM Junctions	Page..... 72	PDI Layout Air-Oil
Page..... 60	Window Units	PDI Layout ZEM
Dualine Anchor Blocks	Sight Feed	PDI Layout FL-33/42/32/43
Anchor Ell	Page..... 73	PDI Layout FL-11/FL-45
	Nozzles	PDI Layout FL1/FL-44
	Page..... 74	PROG Layout 3000
	Inline Filters	PROG Layout M2500G
	Strainers	PROG Layout PVB/PVBM
		PROG Layout U-BLOCK
		DUAL Layout DD/DM

Search Tips:

On your keyboard, push 'control' and the 'F' key together to search by part number or phrase.

Quick Disconnect Couplings Complete	COUPLING	THREADS		BDI PART#	ISO	DIMENSIONS		DRAWINGS
		Female (1)	Male (2)			A	B	
	FS-M	1/8NPT	1/8NPT	B6571		2.09"	.625"	
		Female (1)	Female (2)			A	B	
	FS-F	1/8NPT	1/8NPT	B6576		2.09"	.625"	
		1/4NPT	1/4NPT	U43521	7241-1B	2.80"	.75"	
		3/8NPT	3/8NPT	U43531	7241-1B	2.80"	.75"	
		1/2NPT	1/2NPT	U43541	7241-1B	3.60"	1.125"	
		Male (1)	Male (2)			A	B	
	MS-M12	1/8NPT	1/8NPT	B6574		2.125"	.625"	
		Male (1)	Female (2)			A	B	
	MS-F	1/8NPT	1/8NPT	B6609		2.125"	.625"	

Note: To uncouple quick disconnect coupling, pull knurled sleeve in direction of arrow. To join quick disconnect coupling, push both ends together. An internal check valve prevents flow from line connected on left side, shown above.

Quick Disconnect Couplings Halves-SOCKETS	THREAD	BDI PART #	INFORMATION			DIMENSIONS		DRAWINGS
	Female (1)		CHECK	ISO	USED WITH	A	B	
	1/8NPT	U422AC	ONE-WAY	6150B	U421A, MP	1.906"	.75"	
	1/8NPT	U422A	—	6150B	U421A, MP	1.906"	.75"	
	1/4NPT	UX43521	TWO-WAY	7241-1B	UX43522,TTN,DYN,DYX,BL,AF,MPI	2.265"	.88"	
	1/4NPT	U422BC	ONE-WAY	6150B	U422BC/U421B	2.125"	.75"	
	1/4NPT	U422B	—	6150B	U421BC/U421B	2.125"	.75"	
	3/8NPT	U422C	—	6150B	U421CC/U421C	2.187"	.812"	
	1/2NPT	UX43541	TWO-WAY	7241-1B	UX43542	2.937"	1.19"	
	Female (1)					A	B	
Quick Disconnect Couplings Halves-PLUGS	1/4NPT	UX43522	TWO-WAY	7241-1B	UX43521	1.22"	.75"	
	1/2NPT	UX43542	TWO-WAY	7241-1B	UX43541	2.0"	1.125"	
	MALE (1)							
	1/4BSPT	52043	TWO-WAY	7241-1B	TTN	2.22"	.862"	
	Male (1)					A	B	
Quick Disconnect Couplings Halves-PLUGS	1/8NPT	U421A	—	6150B	U422AC/U422A	1.59"	.50"	
	1/4NPT	U421BC	ONE-WAY	6150B	U422BC/U422B	1.75"	.562"	
	1/4NPT	U421B	—	6150B	U422BC/U422B	1.75"	.562"	
	3/8NPT	U421CC	ONE-WAY	6150B	U422CC/U422C	1.75"	.687"	
	3/8NPT	U421C	—	6150B	U422CC/U422C	1.75"	.687"	

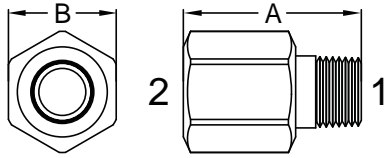
	THREADS		BDI PART #		DIMENSIONS		DRAWING
	Male(1)	Female(2)	Steel	Brass	A	B	
	1/8NPT	1/8NPT	35629-1	A3920	.75"	.50"	
	1/8NPT	1/8NPT	—	A3528	1.0"	.50"	
	1/8NPT	1/8NPT	35629-2	A2540	1.25"	.50"	

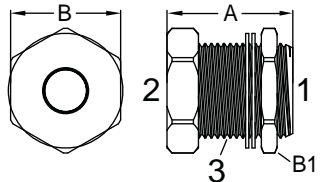
	THREADS			BDI PART #		DIMENSIONS			DRAWING
	Female(1)	Female(2)	Male(3)	Steel	Brass	A	B	B1	
	1/8NPT	1/8NPT	3/4-20	21230-1	—	1.0"	.88"	.88"	
	1/4NPT	1/4NPT	3/4-16	15757	—	0.938"	1.0"	1.0"	
	3/8NPT	3/8NPT	1-14	U162C	—	1.31"	1.0"	1.0"	
	1/2NPT	1/2NPT	1-1/8-14	U162D	—	1.50"	x	x	

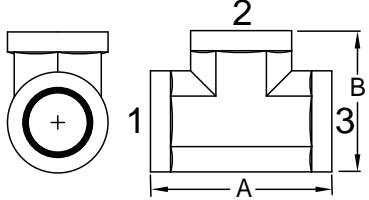
	THREADS			BDI PART #		DIMENSIONS		DRAWING
	Female(1)	Female(2)	Female(3)	Steel	Brass	A	B	
	1/8NPT	1/8NPT	1/8NPT	—	A4071	.562"	.75"	
	1/8NPT	1/8NPT	1/8NPT	—	U137A	1.125"	.563"	
	1/4NPT	1/4NPT	1/4NPT	—	B9592	1.438"	1.625"	
	1/4NPT	1/4NPT	1/4NPT	—	U137B	1.56"	.781"	
	1/4NPT	1/4NPT	1/4NPT	U163B	—	1.8"	.	
	3/8NPT	3/8NPT	3/8NPT	U163C	—	1.94"	.	
	1/2NPT	1/2NPT	1/2NPT	U163D	—	2.5"	.	

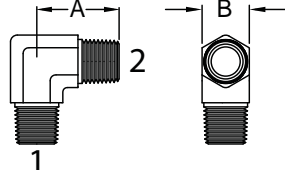
	THREADS		BDI PART #		DIMENSIONS		DRAWING
	Male(1)	Male(2)	Steel	Brass	A	B	
	1/4NPT	1/4NPT	—	27699	1.09"	.50"	
	1/4NPT	1/4NPT	37272	—	1.09"	.56"	
	1/4BSPT	1/4BSPT	35858	—	28MM	28MM	

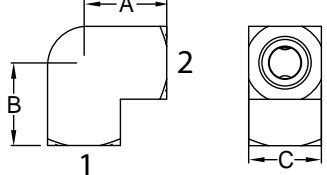
	THREADS		BDI PART #		DIMENSIONS			DRAWING
	Female(1)	Female(2)	Steel	Brass	A	B	C	
	1/8NPT	1/8NPT	—	B8025	.5625"	.5625"	.5625"	
	1/8NPT	1/8NPT	U134A	—	.5468"	.5468"	.5468"	
	1/4NPT	1/4NPT	U134B	—	.781"	.781"	.781"	

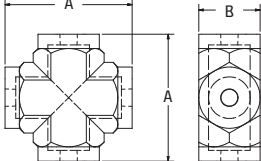
	THREADS				BDI PART #		DIMENSIONS		DRAWING
	Female(1)	Female(2)	Female(1)	Female(2)	Steel	Brass	A	B	
	3/4NPT	3/4NPT	3/4NPT	3/4NPT	32213	-	2.72"	1.313"	
	1/4NPT	1/4NPT	1/4NPT	1/4NPT	37068	-	1.76"	.75"	

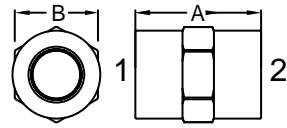
	THREADS		BDI PART #		DIMENSIONS		DRAWING
	Female(1)	Female(2)	Steel	Brass	A	B	
Straight Coupling 	1/8NPT	1/8NPT		B6539	.75"	.50"	
	1/4NPT	1/4NPT	-	B8614	1.12"	.75"	
	1/4NPT	1/4NPT	U112B*	-	1.25"	.72"	
	3/8NPT	3/8NPT	UX84D	-	1.50"	.81"	
	1/2NPT	1/2NPT	U112D*	-	2.12"	1.06"	
	3/4NPT	3/4NPT	U112E*	-	2.0"	1.37"	
	1NPT	1NPT	U112F*	-	2.37"	1.75"	

*No Hex, M.I.

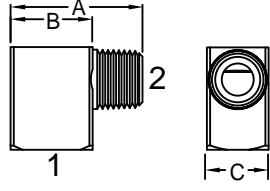
	THREADS		BDI PART #		DIMENSIONS			DRAWING
	Male(2)	Female(1)	Steel	Brass	A	B	C	
90 Degree Elbow Connector 	1/4-28	1/4-28	—	B4453	.53"	.313"		
	1/4-28	1/4-28	—	B6241	.656"	.312"		
	1/8NPT	1/8NPT	—	A2768	.812"	.50"		
	1/8NPT	1/8NPT	—	B1936	.938"	.50"		
	1/8NPT	1/8NPT	—	A2309	1.25"	.50"		
	1/8NPT	1/8NPT	—	B1741	2.0"	.50"		
	1/8NPT	1/8NPT	—	A2539	1.63"	.50"		
	1/8NPT	1/8NPT	—	B1936	.937"	.50"		
	1/8NPT	1/8NPT	U1104AS	—	1.00"	.50"		
	1/4NPT	1/4NPT	—	U152B	1.12"	.688"		
	1/4NPT	1/4NPT	U1104B	—	1.34"	.69"		.69"
	3/8NPT	3/8NPT	U1104C	U152C	1.75"	.88"		1.01"
	1/2NPT	1/2NPT	—	B8930-1	1.97"	1.67"		
	1/2NPT	1/2NPT	32582-1	—	1.97"	1.23"		
	M6X1	M6X1	—	AR108	14MM	8MM		
	M8X1	M8X1	—	AR120	19MM	11MM		

* CHROME

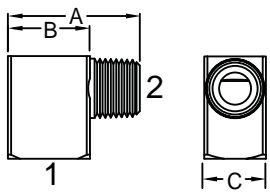
	THREADS		BDI PART #		DIMENSIONS		DRAWING
	Male(2)	Female(1)	Steel	Brass	A	B	
90 Degree Adapter 	10-32	1/8NPT	B7653	—	.81"	.50"	
	1/4-28*	1/8NPT	27718	—	.81"	.50"	
	5/16-32	1/8NPT	B5717	—	.81"	.50"	
	1/8NPT	1/4NPT	U1105A	—	1.18"	.68"	
	1/8NPT	1/4NPT		33224C	1.40"	.82"	
	1/4NPT	3/8NPT	37009	—	1.7"	1.10"	
	1/8BSPT	1/8NPT		19833	.81"	.50"	
	M6X1*	1/8NPT	AR104	—	20MM	.472"	
	M8X1*	1/8NPT	—	AR1682	20.7MM	12.7MM	
	M8X1.25*	1/8NPT	—	AR105	21MM	.50"	
	M10X1.5*	1/8NPT	—	AR106	21MM	.50"	

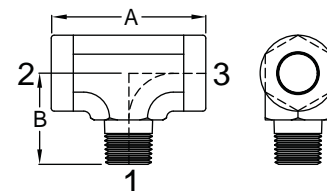
	THREADS			BDI PART #		DIMENSIONS		DRAWING
	Male(1)	Female(2)	Female(3)	Steel	Brass	A	B	
Tee Connectors Male Branch Tee 	1/8NPT	1/8NPT	1/8NPT	—	B4390	.50"	.687"	
	1/4NPT	1/4NPT	1/4NPT	37270	B10101	1.73"	1.1"	

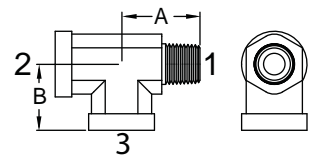
	THREADS			BDI PART #		DIMENSIONS		DRAWING
	Male(1)	Female(2)	Female(3)	Steel	Brass	A	B	
Tee Connectors Male Run Tee 	1/8NPT	1/8NPT	1/8NPT	—	15922	.78"	.55"	
	1/8NPT	1/8NPT	1/8NPT	26978	—	.78"	.66"	
	1/8NPT	1/8NPT	1/8NPT	—	U156A	.656"	.562"	
	1/4NPT	1/4NPT	1/4NPT	19283	—	.78"	.66"	
	1/4NPT	1/4NPT	1/4NPT	—	U156B	.906"	.781"	
	3/8NPT	3/8NPT	3/8NPT	26978-2	—	1.22"	1.02"	

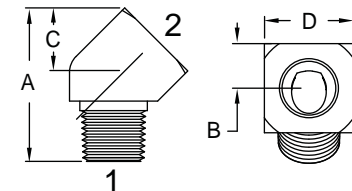
	THREADS			BDI PART #		DIMENSIONS				DRAWING
	Male(1)	Female(2)	Steel	Brass	A	B	C	D	DEGREE	
30, 45 & 60 Deg Elbow Connectors 	1/4-28	1/8NPT	20-6	—	.812"	.25"	.28"	.50"	45 DEG	
	1/8NPT	1/8NPT	—	B3133C	.83"	.25"	.25"	.50"	45 DEG	
	1/8NPT	1/8NPT	—	B2686	.81"	.25"	.25"	.50"	60 DEG	
	1/8NPT	1/8NPT	—	B2778	.93"	.25"	.25"	.50"	60 DEG	
	1/8NPT	1/8NPT	U1103A	—	1.0"	.25"	.25"	.50"	45 DEG	
	1/4NPT	1/4NPT	U1103B	—	1.34"	.34"	.22"	.69"	45 DEG	

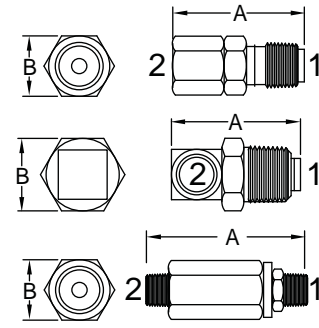
	THREADS			BDI PART #			DIMENSIONS		DRAWINGS
	Male(1)	Female(2)	Steel	Brass	PSI	NOTES	A	B	
Swivel Fittings 	1/8NPT	1/8NPT	B5776	—	20	ELBOW SWIVEL	1.312"	.50"	
	1/8NPT	1/8NPT	B6666	—	20	STRAIGHT SWIVEL	1.312"	.50"	
	1/8NPT	1/8NPT	—	U9975	1000	ELBOW SWIVEL*	2.34"	.562"	
	1/8NPT	1/8NPT	—	22633	20	ELBOW SWIVEL(B5776C)	39MM	.50"	
	1/4NPT	1/4NPT	—	U9976	1000	ELBOW SWIVEL*	2.34"	.562"	
*Internal bearing swivel	Male(1)	Male(2)							
	1/4NPT	1/4NPT	U988B	—	10000	STRAIGHT SWIVEL	2.0"	.75"	

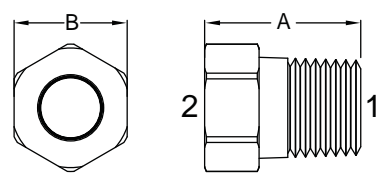
	THREADS		BDI PART #			DIMENSIONS		DRAWING
	Male(1)	Female(2)	Steel	Brass	Stainless	A	B	
Reducing Bushing 	1/8NPT	1/4NPT	—	B9686	—	1.06"	.75"	
	1/4NPT	1/8NPT	—	B6131	—	.625"	.562"	
	1/4NPT	1/8NPT	U104B1	—	—	.625"	.625"	
	3/8NPT	1/8NPT	—	B9955	—	.687"	.687"	
	3/8NPT	1/4NPT	—	B9956	—	.687"	.687"	
	3/8NPT	1/8NPT	U104C1	—	—	.656"	.687"	
	3/8NPT	1/4NPT	U104C2	—	—	.656"	.687"	
	1/2NPT	1/8NPT	—	B9904	—	.812"	.812"	
	1/2NPT	1/4NPT	—	B9953	—	.812"	.812"	
	1/2NPT	1/4NPT	—	—	FIT13682A54	1.08"	.875"	
	1/2NPT	1/8NPT	U104D1	—	—	.75"	.875"	
	1/2NPT	1/4NPT	U104D2	—	—	.75"	.875"	
	1/2NPT	3/8NPT	U104D3	—	—	.75"	.875"	
	3/4NPT	1/4NPT	U104E2	—	—	.84"	1.06"	
	3/4NPT	3/8NPT	U104E3	—	—	.84"	1.06"	
	1NPT	3/8NPT	U104F3	—	—	1.06"	1.437"	
	2NPT	1/2NPT	FIT13682A63	—	—	1.75	2.5"	
	1/4BSPP	1/8BSPT	—	17959	—	.625"	14MM	
	1/4BSPP	1/8NPT	—	17966	—	.625"	14MM	
	1BSPP	1/4NPT	B10485	—	—	1.03"	1.625"	

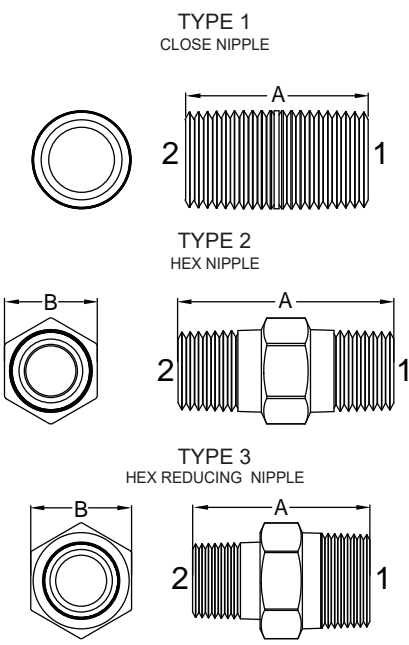
	THREADS		BDI PART #			DIMENSIONS			DRAWINGS
	Male(1)	Male(2)	Steel	Brass	Stainless	A	B	TYPE	
Nipples 	5/16-24	5/16-24	—	20124*	—	1.156"	.375"	2	
	1/8NPT	1/8NPT	-	A4019	—	.828"	.375"	2	
	1/8NPT	1/8NPT	35790-1	—	35639	1.01"	.437"	2	
	1/8NPT	1/4-28	27715	—	—	1.21"	.437"	3	
	1/8NPT	5/16-24	—	B4317	—	.875"	.375"	3	
	1/4NPT	1/4NPT	35790-2	—	—	1.375"	.625"/.562"	2	
	1/4NPT	1/4NPT	—	U15122	—	1.375"	.562"	2	
	1/4NPT	1/4NPT	—	7108415	—	.875"	-	1	
	1/4NPT	1/8NPT	35790-5	B9593	—	1.19"	.562"	3	
	1/4NPT	1/8NPT	—	22675	—	33MM	16MM	3	
	3/8NPT	3/8NPT	35790-3	32485-1	—	1.41"	.687"/.75"	2	
	3/8NPT	3/8NPT	—	—	35665	1.0"	-	1	
	3/8NPT	3/8NPT	FIT13682A12	—	—	1.5"	.687"	2	
	3/8NPT	3/8NPT	FIT13682A13	—	—	2.0"	.687"	2	
	3/8NPT	1/4NPT	35790-6	U15132	—	1.40"	.562"	3	
	1/2NPT	1/2NPT	35790-4	—	—	1.89"	.875"	3	
	1/2NPT	1/2NPT	FIT13682A5	—	—	2.0"	.875"	2	
	1/4BSPT	1/4BSPT	35857	AR697	—	35MM / 27MM	14MM	2	
	M8X1	M8X1	—	34957C	—	13MM	-	1	
	M8X1	M8X1	—	15822*	—	.828"	10MM	2	
M10X1	M10X1	—	34958C	—	15MM	-	1		
M10X1	M10X1	—	60414-1**	—	16MM	-	1		
M10X1	M10X1	—	25632*	—	26MM	11MM	1		
M10X1	M10X1	—	AR1110	—	21MM	10MM	2		
M12X1	M12X1	—	34959C	—	17MM	-	1		
M12X1	M12X1	—	60414-2**	—	18MM	-	1		

* JUNCTION BAR CONNECTOR

** INCLUDES INTERNAL 5MM HEX ONE END

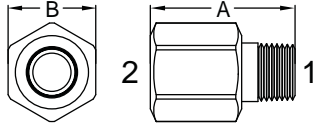
	THREADS		BDI PART #			DIMENSIONS		DRAWING
	Male(1)	Female(2)	Steel	Brass	Stainless	A	B	
Straight Adapter 	10-32*	1/8NPT	—	32667	—	.70"	.437"	
	1/4-28*	1/8NPT	B4311	—	—	3/4"	.50"	
	1/4-28*	1/8NPT	20-1	—	—	.875"	.50"	
	1/8NPT	1/8BSPP	—	26718	—	17.65MM	14MM	
	1/8NPT	1/4NPT	—	B9686	—	1.06"	.75"	
	1/8NPT	1/4NPT	202-2	—	—	1.05"	.625"	
	1/4NPT	3/8NPT	U1106B	—	—	1.44"	.88"	
	1/4NPT	1/8BSPT	—	19583	—	.75"	.562"	
	3/8NPT	1/2NPT	U1106C	—	—	1.62"	1.0"	
	1/8BSPP	1/8NPT	B10279-3	—	—	7/8"	.562"	
	1/4BSPP	1/4NPT	B10279-4C	—	—	1-3/16"	.75"	
	1/4BSPP	1/8BSPP	AR351	—	—	28MM	19MM	
	1/4BSPP	1/8NPT	B10279-7C	—	—	1"	.75"	
	1/8BSPT	M10X1	—	17020	—	1"	14MM	
	1/8BSPT	1/8NPT	—	35673	—	21MM	14MM	
	1/8BSPT	1/8NPT	79S2A2RT	—	—	1.0"	.562"	
	1/4BSPP	1/8BSPP	73490-2123	—	—	28MM	19MM	
	1/4BSPT	1/4NPT	—	35673-1	—	28.5MM	17MM	
	1/4BSPT	1/4NPT	36465	—	36465-SS	1.37"	.75"	
	1/4BSPP	3/8BSPP	73490-2143	—	—			
	3/8BSPP	3/8NPT	B10279-5	—	—	1-1/4"	.875"	
	3/8BSPT	3/8NPT	36465-2	—	—	1.38"	.875"	
	3/8BSPT	3/8NPT	—	35673-2	—	29.5MM	22MM	
	1/2BSPT	1/2NPT	36465-3	—	—	1.88"	1.125"	
	3/4BSPT	3/4NPT	36465-4	—	—	1.95"	1.375"	
	1BSPT	1NPT	36465-5	—	—	2.38"	1.625"	
	M5	1/8NPT	—	35622	—	.575"	14MM	
	M6X1*	1/8NPT	AR101	—	—	20MM	13MM	
	M8X1*	1/8NPT	—	AR215	—	20MM	13MM	
	M8X1	1/8BSPT	—	17194	—	13/16"	14MM	
	M8X1.25*	1/8NPT	—	AR102	—	19MM	13MM	
	M10X1	1/8NPT	B10279-1C	—	—	7/8"	.562"	
M10X1	1/4BSPP	AR514	—	—	28MM	17MM		
M10X1.5*	1/8NPT	—	AR103	—	19MM	13MM		
M12X1	1/8NPT	B10279-2C	—	—	7/8"	.625"		
M16X1.5	1/8NPT	—	42444-5	—	32MM	19MM		
M22X1.5	M20X1.5	56871	—	—	34MM	24MM		

* TAPERED

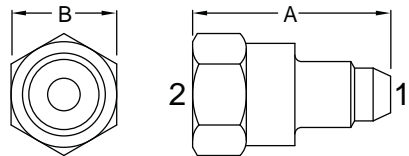
	THREADS		BDI PART #		DIMENSIONS		DRAWING
	Male(1)	Female(2)	Steel	Brass	A	B	
Straight Adapter Bijur Special 	5/16-24	1/8NPT	36054	B6056	15/16"	.50"	

	TUBE / THREADS		BDI PART #			DIMENSIONS		DRAWING
	Tube OD(1)	Male(2)	Steel	Brass	Stainless	Notes	A	
Straight Tubing Adapter Assembly 	1/8	1/4-28	—	27727	35722		.82"	.375"
		1/8NPT	—	27594-1	35655-1		.97"	.437"
		1/8NPT	—	27726	—		.82"	.437"
	5/32	1/8NPT	—	B3297	—		.875"	.375"
		1/8NPT	32995	—	—		28MM	11MM
	3/16	1/8NPT	—	35435	—	CAPTIVE SLEEVE	1.07"	.437"
		1/8NPT	—	B10285	—		1.08"	.437"
		1/8NPT	U83A1	U83A1B	—		1.06"	.50"
		1/4NPT	U83A2	—	—		.968"	.562"
		1/8BSPT	B10407	—	—		1.0"	.437"
	1/4	1/8NPT	B10090-1	B6534	32420-2		1.10"	.437"
		1/8NPT	—	B10224-3	—		1.0"	.437"
		1/8NPT	U83B1	U83B1B	—		1.125"	.50"
		1/4NPT	B10090-2	B6533	32420-1		1.30"	.562"
		1/4NPT	U83B2	—	—		1.125"	.625"
		3/8NPT	U83B3	—	—		1.125"	.75"
		1/8BSPT	—	15578	—		1.10"	.437"
		1/8BSPP	B10176-3	—	—		1.50"	.562"
		1/4BSPP	B10176-4C	—	—		1.625"	.75"
		1/4BSPT	20806	—	—		1.75"	.562"
		M10X1	B10176-1	—	—		1.50"	.562"
	M12X1	B10176-2	—	—		1.50"	.625"	
	5/16	1/8NPT	—	35532	—	CAPTIVE SLEEVE	1.13"	.562"
		1/8NPT	B10090-3	—	—		1.10"	.562"
		1/4NPT	—	35533	—	CAPTIVE SLEEVE	1.35"	.562"
		1/4BSPP	B10176-5	—	—		1.75"	.75"
	3/8	1/8NPT	—	35436	—	CAPTIVE SLEEVE	1.19"	.625"
		1/8NPT	7962FBUS	—	34046		1.75"	.75"
		1/4NPT	U83D2	U83D2B	34045		1.75"	.75"
		1/4NPT	B10090-5	—	—		1.8"	.687"
		1/4NPT	—	35437	—	CAPTIVE SLEEVE	1.36"	.625"
		1/4NPT	—	B6514	—		1.42"	.562"
		3/8NPT	U83D3	—	—		1.562"	.75"
	1/4BSPP	B10176-6	—	—		1.75"	.75"	
	1/2	1/4NPT	—	U73EM2	—		1.8"	.866"
		1/4NPT	U53EM2	—	—		1.10"	.812"
		3/8NPT	U53EM3	—	55310		1.10"	.812"
		3/8NPT	—	U73EM3	—		1.8"	.866"
		1/2NPT	—	U73EM4	—		2.14"	1.01"
	1/2NPT	U53EM4	—	—		1.30"	.875"	
	4MM	1/8BSPT	73442-1114	—	—		28MM	10MM
		1/8BSPT	AR974	—	—		25MM	10MM
	6MM	1/4-28	53669-1T	—	—		36.5MM	11MM
		1/8NPT	AR138	—	—		25MM	11MM
		1/8NPT	24361-1	—	—		28MM	11MM
		1/8BSPP	73442-1214	—	—		31MM	14MM
		1/8BSPT	AR154	—	—		27MM	11MM
		1/4BSPP	34989	—	—		40MM	19MM
		1/4BSPP	AR397	—	—	L 300 bar	33.5MM	14MM
		1/4BSPP	AR959	—	—	S 400 bar	40MM	19MM
		M6X1	AR1594	—	—		28.5MM	11MM
		M8X1	53669T	—	—		36.5MM	11MM
		M10X1	73442-1244	—	—		31MM	14MM
	M10X1	AR426	—	—		33MM	14MM	
	M12X1	FB1098	—	—		46.5MM	17MM	
	8MM	1/8NPT	AR167	—	—		32MM	14MM
		1/4BSPP	AR384	—	—		35MM	17MM
		M10X1	73442-1344	—	—		28MM	12MM
		M10X1	AR1028	—	—		34MM	17MM
		M12X1	AR1027C	—	—		35MM	17MM
M14X1.5		AR1280	—	—		40MM	19MM	
10MM	1/8NPT	-	AR265	—			19MM	
	1/4NPT	36183	—	—		39MM	19MM	
	1/8BSPP	AR898	—	—		35.5MM	17MM	
	1/4BSPP	AR385	—	—		36MM	19MM	
	M14X1.5	AR1417	—	—		36MM	19MM	
	M16X1.5	AR906	—	—		40MM	22MM	
12MM	1/4BSPP	AR790	—	—		26.5MM	22MM	
	M14X1.5	AR1281	—	—		27MM	22MM	

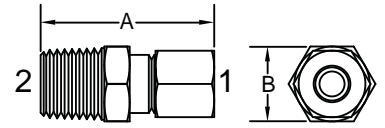

	TUBE/THREADS		BDI PART #			DIMENSIONS		DRAWING
	Tube OD(1)	Male(2)	Steel	Brass	Stainless	Notes	A	
90 Degree Tubing Adapter Assembly 	1/8	1/4-28	—	27728	—		.50"	.515"
		1/8NPT	—	—	35655-2		.656"	.75"
		1/8NPT	—	27725	—		.50"	.656"
	5/32	1/8NPT	—	B3298	—		.812"	.875"
	3/16	1/8NPT	—	B10286	—		.625"	.687"
		1/8NPT	—	35438	—	CAPTIVE SLEEVE	.61"	.69"
	1/4	1/8NPT	—	B6536	—		.687"	.812"
		1/8NPT	—	B10390-1	—		.62"	.75"
		1/8NPT	B10092-2	—	—		.89"	.78"
		1/4NPT	—	B6535	—		.687"	.812"
		1/4NPT	B10092-1	—	—		1.03"	1.09"
	5/16	1/8NPT	—	35534	—	CAPTIVE SLEEVE	.61"	.74"
		1/4NPT	—	35535	—	CAPTIVE SLEEVE	.71"	.93"
		1/4NPT	B10092-3	—	—		1.03"	1.09"
	3/8	1/8NPT	—	35439	—	CAPTIVE SLEEVE	.74"	.74"
		1/4NPT	—	B6519	—		.812"	.875"
		1/4NPT	B10092-4	—	—		1.25"	.968"
		1/4NPT	—	35440	—	CAPTIVE SLEEVE	.74"	.93"
		1/4NPT	—	B10287-1	—	45 DEG	.55"	.80"
	1/2	3/8NPT	U57EM3	—	55311		.50"	1.25"
	4MM	1/8BSPT	AR975	—	—		9.5MM	12MM
	6MM	1/4-28	53670-1T	—	—		15.5MM	19.6MM
		1/8NPT	AR139	—	—		9.5MM	13MM
		1/8BSPT	AR156	—	—		9.5MM	12MM
		1/4BSPT	AR961	—	—	S 400 bar	16MM	26MM
		M10X1	AR904	—	—		9.5MM	12MM
	8MM	1/8NPT	AR173	—	—		-	-
		1/8BSPT	AR174	—	—		-	-
1/4BSPT		AR794	—	—		14MM	18MM	
M10X1		AR617	—	—	SWIVEL TAPERED	11.5MM	15MM	
10MM	1/4BSPT	AR157	—	—		15MM	19MM	

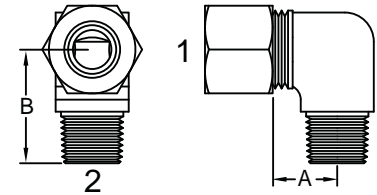

	TUBE		BDI PART #		DIMENSIONS			DRAWING
	Tube(1)	Tube(2)	Steel	Brass	INFO	A	B	
Straight Tubing Coupling Assembly 	5/32	5/32	—	B5163	METAL	1.0"	.375"	.375"
	5/32	5/32	—	20657	NYLON	1.0"	.375"	.375"
	3/16	3/16	—	35441	CAPTIVE SLEEVE	.72"	.562"	.437"
	1/4	1/4	B10094-1	—		1.17"	.562"	.50"
	1/4	1/4	B10502-1	—	BULKHEAD	1.13"	.687"	.687"
	1/4	1/4	U84B	—		1.06"	.437"	.562"
	5/16	5/16	—	35536	CAPTIVE SLEEVE	.85"	.437"	.50"
	3/8	3/8	—	35442	CAPTIVE SLEEVE	.97"	.625"	.562"
	3/8	3/8	U84D	—		1.50"	.687"	.812"
	1/2	1/2	—	U74EE		1.09"	.75"	.866"
	4MM	4MM	AR993	—		12MM	10MM	9MM
	6MM	6MM	AR825	—	BULKHEAD	34MM	14MM	14MM
	8MM	8MM	AR184	—		11MM	17MM	14MM

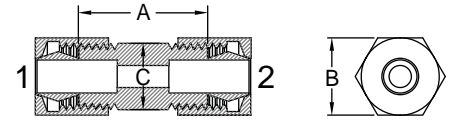

	TUBE / THREADS		BDI PART #		DIMENSIONS			DRAWING
	Tube OD(1)	Female(2)	Steel	Brass	INFO	A	B	
90 Degree Tubing Adapter Assembly 	3/16	1/8NPT	—	35445	CAPTIVE SLEEVE	.98"	.56"	
	3/8	1/2NPT	—	U164K		1.56"	1.18"	

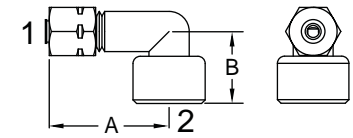

	TUBE / THREADS		BDI PART #		DIMENSIONS		DRAWING
	Tube OD(1)	Female(2)	Steel	Brass	A	B	
Straight Tubing Adapter Assembly 	1/4	1/8NPT	—	B8026	.875"	.50"	

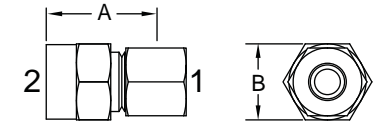

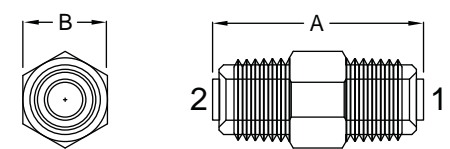

	THREADS / TUBE				BDI PART #		DIMENSIONS		DRAWING
	Male for Tube OD (1)		Male for Tube OD (2)		Steel	Brass	A	B	
	Tube OD	Thread	Thread	Tube OD					
Straight Tubing Adapter Body  Used with B1095 & B1061/B8272.	5/32	5/16-24	5/16-24	5/32	—	B2306	1.0"	.375"	

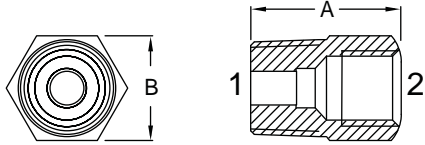

	THREADS / TUBE			BDI PART #		DIMENSIONS		DRAWING
	Male (1)	Female for Tube OD (2)		Steel	Brass	A	B	
		Thread	Tube OD					
Straight Tubing Adapter Body  See page 18-19 for compression sleeves and bushings.	1/4-28	5/16-24	3/32	B4316**	—	3/4"	.375"	
	1/4-28	5/16-24	4MM-5/32	B4312**	—	3/4"	.375"	
	1/4-28	5/16-24	4MM-5/32	—	B2626	1"	.375"	
	1/8NPT	5/16-24	3/32	—	B3430	5/8"	.437"	
	1/8NPT	5/16-24	4MM-5/32	—	A2835	5/8"	.437"	
	1/8NPT	5/16-24	4MM-5/32	—	B1525	3/4"	.437"	
	1/8NPT	5/16-24	4MM-5/32	—	B10017	1-1/4"	.50"	
	1/8NPT	5/16-24	4MM-5/32	—	B1531	1-1/2"	.437"	
	1/8NPT	5/16-24	4MM-5/32	—	B7768**	1-1/2"	.437"	
	1/8NPT	M10X1	6MM	—	26686	18.92MM	14MM	
	1/8NPT	M8X1	4MM-5/32	—	19172	0.63"	11MM	
	1/8NPT	5/16-24	4MM-5/32	—	B3488	.687"	.437"	
	1/8BSPP	M8X1	4MM-5/32	—	20326	.798"	.50"	
	1/8BSPT	M8X1	4MM-5/32	—	15352	.63"	11MM	
	1/8BSPT	5/16-24	4MM-5/32	—	B8884	5/8"	.437"	
	1/8BSPT	3/8-24	3/16	B9931	—	3/4"L	.437"	
	1/8BSPT	M8X1	4MM-5/32	—	15318	0.63"	11MM	
	M6X.75	5/16-24	4MM-5/32	—	24226	20MM	11MM	
	M6X1	M8X1	4MM-5/32	—	19453	0.815"	11MM	
	M6X1*	5/16-24	4MM-5/32	—	B10323-1	17MM	.394"	
M8X1*	5/16-24	4MM-5/32	—	B10323-3	16MM	.433"		
M10X1	M8X1	4MM-5/32	—	AR1113	16MM	11MM		
M12X1	M10X1	6MM	34987	—	20MM	17MM		

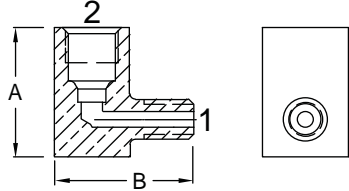
* TAPERED **ZINC

	THREADS / TUBE			BDI PART #		DIMENSIONS		DRAWING
	Male (1)	Female for Tube OD (2)		Steel	Brass	A	B	
		Thread	Tube OD					
90 Degree Elbow Adapter Body  See page 18-19 for compression sleeves and bushings.	1/4-28	5/16-24	5/32-4MM	19285	—	.625"	.88"	
	5/16-24	5/16-24	5/32-4MM	—	20131	20MM	.88"	
	1/8NPT	5/16-24	3/32	—	B3431	.562"	.81"	
	1/8NPT	5/16-24	5/32-4MM	—	A3080	.562"	.81"	
	1/8BSPT	5/16-24	5/32-4MM	—	B8883	.562"	.81"	
	1/8BSPT	M8X1	5/32-4MM	—	15320-1	.48"	1.0"	
	M6X1	5/16-24	5/32-4MM	—	21238	20MM	22.4MM	
	M6X1	M8X1	5/32-4MM	—	24528	20MM	22.4MM	
	M8X1	M8X1	5/32-4MM	—	26810	19.1MM	20MM	
	M10X1	M8X1	5/32-4MM	—	AR1112			

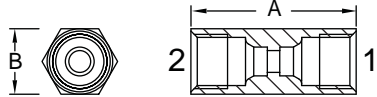
	THREADS / TUBE				BDI PART #		DIMENSIONS		DRAWING
	Female for Tube OD (1)		Female for Tube OD (2)		Steel	Brass	A	B	
	Tube OD	Thread	Thread	Tube OD					
Straight Tubing Coupling Body 	5/32	5/16-24	5/16-24	5/32	—	A2899	.94"	.375"	
	4MM	M8X1	M8X1	4MM	—	19450	.94"	.39"	

* See page 18-19 for tubing connections.

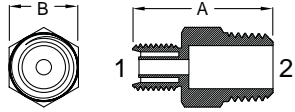
	THREADS / TUBE		BDI PART #		DIMENSIONS		DRAWING	
	Male for Tube OD (1)		Male (2)	Steel	Brass	A		B
	Thread	Tube OD						
Straight Tubing Adapter Body 	1/4-28	3/32	1/4-28	—	B4452	.594"	.312"	
	1/4-28	3/32	M6X1*	—	AR107	15mm	8mm	
	5/16-24	5/32	5/16-24	—	B3794	1.2"	.375"	
	1/8NPT	5/32	5/16-24	—	B2253	.90"	.375"	
	1/8NPT	1/4	7/16-24	—	B6086	.86"	.437"	
	1/2-24	5/16	1/8NPT	—	B150	.81"	.50"	
	1/2-24	5/16	1/4NPT	—	B151	1.09"	.562"	
	1/4NPT	1/4	7/16-24	—	B7903	1.3"	.562"	
	1/4BSPT	1/4	7/16-20	19205	—	1.2"	.562"	

*Taper

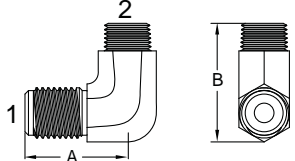
	THREADS / TUBE		BDI PART #		DIMENSIONS		DRAWING	
	Male (2)	Male for Tube OD (1)		Steel	Brass	A		B
		Thread	Tube OD					
90 Degree Tubing Adapter Body 	1/8NPT	3/8-24	3/16	B7747	—	.62"	.69"	
	1/8NPT	7/16-24	1/4	—	B7743	.75"	.80"	
	1/4NPT	7/16-24	1/4	—	B9852	.62"	.75"	

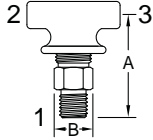
	THREADS / TUBE				BDI PART #		DIMENSIONS		DRAWING	
	Female for Tube OD (2)		Female for Tube OD (3)		Male (1)	Steel	Brass	A		B
	Thread	Tube OD	Thread	Tube OD						
Tee Tubing Adapter 	5/16-24	5/32	5/16-24	5/32	5/16-24	—	20632	1.156"	.375"	

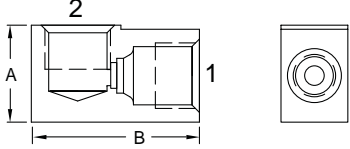
	THREADS / TUBE		BDI PART #		DIMENSIONS		DRAWING		
	Female (2)	Female for Tube OD (1)		Steel	Brass	A		B	
		Thread	Tube OD						
90 Degree Elbow Tubing Adapter 	1/8NPT	5/16-24	5/32	—	B3921	.50"	.90"		

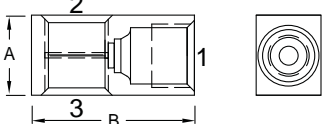
	THREADS / TUBE		BDI PART #		DIMENSIONS		DRAWING		
	Female (2)	Female (3)	Female for Tube OD (1)		Steel	Brass		A	B
			Thread	Tube OD					
Female Tee Tubing Adapter 	1/8NPT	1/8NPT	5/16-24	5/32	—	A4042	.50"	.90"	

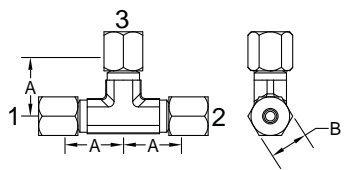
	TUBE			BDI PART #		DIMENSIONS			DRAWING
	Tube(1)	Tube(2)	Tube(3)	Steel	Brass	NOTES	A	B	
Tee Tubing Adapter Assembly 	5/32-4MM	5/32-4MM	5/32-4MM	B10093-7	—		.60"	10MM	
	1/4	1/4	1/4	—	B8109		.625"	.50"	
	5/16	5/16	5/16	—	35537	CAPTIVE SLEEVE	.74"	.562"	
	3/8	3/8	3/8	—	35444	CAPTIVE SLEEVE	.74"	.625"	
	3/8	3/8	3/8	B10093-3	—		1.05"	.687"	
	1/2	1/2	1/2	B10093-4	U70EEE		.843"	.625"	
	6MM	6MM	6MM	35004	—		12MM	14MM	
	8MM	8MM	8MM	AR180	—		29MM	17MM	
	10MM	10MM	10MM	AR181	—				

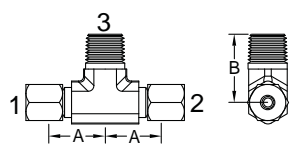
	TUBE / THREADS			BDI PART #		DIMENSIONS		DRAWING
	Tube(1)	Tube(2)	Male(3)	Steel	Brass	A	B	
Male Branch Tee Tubing Assembly 	1/4	1/4	1/4NPT	15209-3	—	1.03"	1.09"	
	3/8	3/8	1/8NPT	—	35443	.75"	.75"	

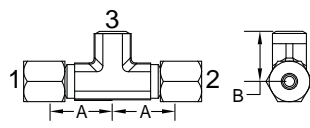
	TUBE / THREADS			BDI PART #		DIMENSIONS		DRAWING
	Tube(1)	Tube(2)	Female(3)	Steel	Brass	A	B	
Female Branch Tee Tubing Assembly 	1/4	1/4	1/8NPTF	B10091-1	—	.89"	.66"	
	1/2	1/2	3/8NPTF	B10091-3	-	1.23"	1.02"	

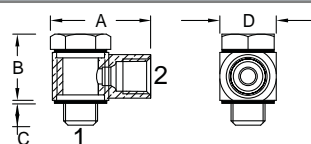
	THREADS / TUBE			BDI PART #		DIMENSIONS				DRAWING
	Male (1)	Female for Tube OD (2)		Steel	Brass	A	B	C	D	
		Thread	Tube OD							
Banjo Tubing Adapter Body 	5/16-24	5/16-24	4MM 5/32	—	20156	22.6MM	15.2MM	5MM	13MM	
	M6X1	5/16-24	4MM 5/32	—	24656	22.5MM	15MM	7.5MM	12MM	
	M8X1	M8X1	4MM 5/32	—	19776	22.5MM	13.5MM	6MM	13MM	

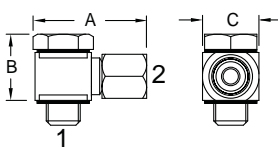
	THREADS / TUBE		BDI PART #		DIMENSIONS			DRAWING	
	Tube OD (2)	Male (1)	Steel	Brass	A	B	C		
Banjo Tubing Adapter Assembly 	4MM	1/8BSPP	73442-7113	—	28MM	21MM	14MM		
	6MM	M10X1	34992	—	24MM	18MM	14MM		
	6MM	M12X1	34994	—	33MM	23.5MM	17MM		
	6MM	1/4BSPP	34997	—	33MM	25MM	17MM		
	6MM	M10X1	AR1021	—	36MM	25.5MM	18MM		
	6MM	1/4BSPP	AR1032	—	42MM	30MM	22MM		
	8MM	M10X1	AR1029	—	32MM	22MM	14MM		
	8MM	M12X1.5	AR1023	—	36.5MM	25MM	17MM		
	8MM	M14X1.5	AR1033	—	42MM	30.5MM	22MM		
	8MM	1/4BSPP	AR982	—	40MM	30MM	22MM		
	10MM	M16X1.5	AR137	—	43MM	32MM	22MM		
	10MM	M14X1.5	AR553	—	41MM	30.5MM	22MM		
	10MM	1/4BSPP	AR983	—	41MM	30.5MM	22MM		

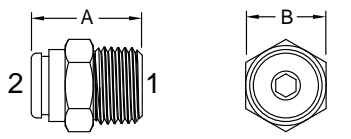
	QC TUBE / THREADS		BDI PART #		DIMENSIONS		DRAWING
	Tube OD (2)	Male (1)	Brass	Ni-Brass	A	B	
Straight Quick Connect Tubing Adapter Assembly 	1/8	1/8NPT	—	20101-9	14.5MM	11MM	 AR5005 290 psi / 20 bar max
	5/32-4MM	5/16-24	AR5005	—	23.9MM	11MM	
		1/8NPT	—	20101-1	16.5MM	11MM	
		10-32	—	27393	17.5MM	.34"RND	
		1/4-28	—	35746-1	.88"	7/16"	
		1/8BSPT	—	85492-2	19.3MM	10MM	
		1/4BSPT	—	35262	16.5MM	14MM	
		M8X1	—	AR5076	22.5MM	10MM	
	M6X1	—	AR1849	26MM	14MM		
	3/16	1/8NPT	—	20101-10	23.5MM	.437"	
	1/4	1/8NPT	—	20101-4	19.4MM	11MM	
		1/4NPT	—	20101-5	20.4MM	14MM	
		1/8BSPT	—	20101-7	18.4MM	11MM	
	5/16	1/4BSPT	—	20101-8	18.8MM	14MM	
		1/8NPT	—	20101-2	27.3MM	13MM	
	3/8	1/4NPT	—	20101-3	27.8MM	14MM	
		1/4NPT	—	20101-12		16MM	
	6MM	1/8NPT	—	20101-6	20.2MM	11MM	
		M10X1	—	AR1855	23MM	13MM	
		M8X1	—	AR5016	22.5MM	13MM	
		M12X1	—	AR2052	23MM	16MM	
		1/8BSPT	—	21459-2	18.5MM	11MM	
		1/4BSPP	—	AR5017	23.5MM	16MM	
		1/4BSPT	—	AR1979	24MM	14MM	
		M6X1	—	AR2050			
	8MM	M10X1	—	AR2158	27.6MM	14MM	
		M12X1	—	AR2019			
		1/8BSPP	—	AR1997	27.4MM	14MM	
10MM	1/4BSPP	—	AR2013	27.4MM	16MM		
	1/4BSPP	—	AR1725	35.4MM	17MM		
12MM	M12X1	—	AR2058				
	1/4BSPP	—	AR2043	36MM	20MM		

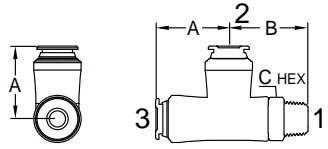
	QC TUBE / THREADS			BDI PART #		DIMENSIONS			DRAWING
	Tube OD (2)	Tube OD (3)	Male (1)	Steel	Ni-Brass	A	B	C	
Tee Male Branch Quick Connect Coupling Assembly 	5/16	5/16	1/4NPT	-	328071	.84"	1.46"	.562"	 290 psi / 20 bar max

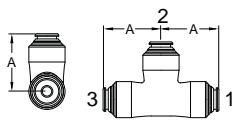
	QC TUBE			BDI PART #		DIMENSIONS	DRAWING
	Tube OD (1)	Tube OD (2)	Tube OD (3)	Steel	Ni-Brass	A	
Tee Quick Connect Coupling Assembly 	4MM	4MM	4MM	—	AR2132	18MM	 290 psi / 20 bar max QC fittings for use with Nylon tubing
	6MM	6MM	6MM	—	AR2134	20MM	
	8MM	8MM	8MM	—	AR2135	22MM	
	10MM	10MM	10MM	—	AR2136	28MM	
	12MM	12MM	12MM	—	AR2137	30MM	

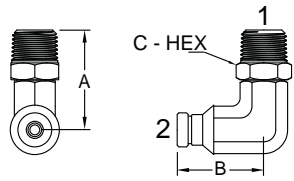
	QC TUBE / THREADS		BDI PART #		DIMENSIONS			DRAWING	
	Tube OD (2)	Male (1)	Steel	Ni-Brass	A	B	C		
90 Degree Quick Connect Tubing Adapter Assembly 	1/8	1/8NPT	—	32394-1	.67"	.74"	-		
	5/32-4MM	1/8NPT	—	15920-1	22MM	18MM	.406"		
		1/4-28	—	35746-2	.48"	.60"	-		
		10-32	—	27305	.93"	.726"	.437"		
		M6X1	—	AR2120	17MM	17MM	10MM		
		M8X1	—	AR2121	18MM	17MM	11MM		
	1/4	1/8NPT	—	32712-1	.884"	.885"	.472"		
		1/4NPT	—	32712-2	.904"	.885"	.551"		
	5/16	1/8NPT	—	15920-2	24.5MM	23.5MM	.50"		
		1/4NPT	—	15920-4	28.5MM	23.5MM	.562"		
	6MM	1/8NPT	—	32179-1	18.9MM	16MM	10MM		
		M10X1	—	AR2113	30MM	19MM	14MM		
		M12X1	—	AR1988	30MM	20MM	16MM		
		M6X1	—	AR2111					
		M8X1	—	AR2112					
		1/8BSPT	—	AR1980	14MM	21MM	20MM		
	8MM	1/4BSPP	—	AR2089	33MM	20MM	19MM		
		1/4BSPT	—	AR1981	14MM	21MM	20MM		
		1/2NPT	-	37306	22.5MM		22MM		
		M10X1	—	AR2114	32MM	21MM	14MM		
M12X1		—	AR2115	32MM	20MM	16MM			
1/4BSPP		—	AR2091	35MM	22MM	19MM			
10MM	1/8BSPT	—	32179	18.9MM	23MM	10MM			
	M12X1	—	AR2117	40MM	27.5MM	17MM			
	1/4BSPP	—	AR2093	39MM	28MM	19MM			
12MM	1/4BSPP	—	AR2095	41MM	30MM	19MM			

290 psi / 20 bar max

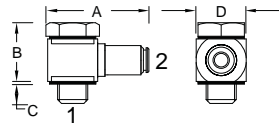
	QC TUBE		BDI PART #		DIMENSIONS				DRAWING
	Tube OD (2)	Male (1)	Steel	Ni-Brass	A	B	C	D	
90 Degree Quick Connect Tubing Banjo Assembly 	4MM	M10X1	—	34763		20MM	8MM	14MM	
	6MM	M12X1	—	AR2142					
	6MM	1/8BSPP	—	AR2143	30MM	20MM	8MM	14MM	
	6MM	1/4BSPP	—	AR2144	30MM	20MM	8MM	14MM	
	8MM	M10X1	—	AR2145					
	8MM	M12X1	—	AR2146					
	12MM	M12X1	—	AR2152					

290 psi / 20 bar max

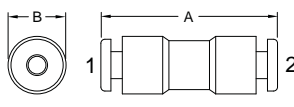
	QC TUBE		BDI PART #		DIMENSIONS		DRAWING
	Tube OD (1)	Tube OD (2)	Nylon	Ni-Brass	A	B	
Straight Quick Connect Coupling Assembly 	5/32	5/32	35526	—	.98"		
	1/4	1/4	34021-1	—	1.37"	.59"	
	4MM	4MM	60075	AR2059	33MM	10MM	
	6MM	6MM	—	AR2061	36MM	12MM	
	8MM	8MM	—	AR2062	38MM		
	10MM	10MM	—	AR2063			

290 psi / 20 bar max

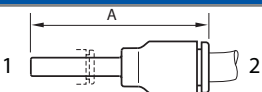
	QC TUBE		BDI PART #		DIMENSIONS		DRAWING
	Standpipe O.D. (1)	Tube OD (2)	Nylon	Ni-Brass	A	NOTES	
Str. QC Expander 	4MM	6MM	AR2210	—	37MM		
	6MM	1/4"	35749	—	1.75"		

QC fittings for use with Nylon tubing

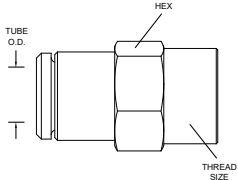
	QC TUBE / THREADS		BDI PART #	DIMENSIONS	DRAWING
	Tube OD	Male	Ni-Brass	HEX	
Straight HP Quick Connect Tubing Adapter 	1/4	1/8NPT	AR5206	12mm	 1160 psi / 80 bar max
		1/4-28	AR5205*	12mm	
	4MM	1/8NPT	AR5227	11mm	
		1/4-28	AR5228	11mm	
		1/8BSPT	AR5141*	10mm	
		M6X1 Tap	AR5132*	10mm	
		M8X1 Tap	AR5135*	10mm	
		M10X1 Tap	AR5138	11mm	
	6MM	1/8NPT	AR5202	12mm	
		1/4-28	AR5221*	12mm	
		1/8BSPT	AR5114	12mm	
		M6X1 Tap	AR5196*	12mm	
M8X1 Tap		AR5220*	12mm		
	M10X1 Tap	AR5203*	12mm		

* Order mins may apply

1160 psi / 80 bar max

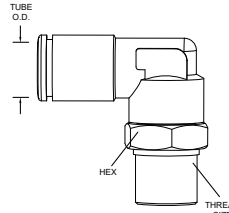
	QC TUBE / THREADS		BDI PART #	DIMENSIONS	DRAWING
	Tube OD	Male	Ni-Brass	HEX	
90 Deg Swivel HP Quick Connect Tubing Adapter 	1/4	1/8NPT	AR5204	12mm	 1160 psi / 80 bar max
		1/4-28	AR5207	12mm	
		1/4BSPT	AR5184	14mm	
	4MM	1/8NPT	AR5225	11mm	
		1/4-28	AR5226*	11mm	
		1/8BSPT	AR5143*	10mm	
		M6X1 Tap	AR5134	10mm	
		M8X1 Tap	AR5137*	10mm	
		M10X1 Tap	AR5140*	11mm	
	6MM	1/8NPT	AR5194	12mm	
		1/4-28	AR5223	12mm	
		1/8BSPT	AR5130	12mm	
		M6X1 Tap	AR5129	12mm	
		M8X1 Tap	AR5197	12mm	
		M10X1 Tap	AR5222*	12mm	

* Order mins may apply

1160 psi / 80 bar max

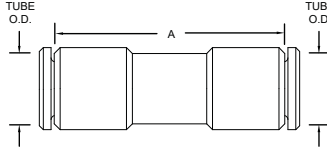
	QC TUBE / THREADS		BDI PART #	DIMENSIONS	DRAWING
	Tube OD	Tube OD	Ni-Brass	A	
Union HP Quick Connect Tubing Adapter Assembly 	1/4	1/4	AR5210	30mm	 1160 psi / 80 bar max
	5/32-4MM	5/32-4MM	AR5229	26mm	
	6MM	6MM	AR5224	29.5mm	







* Order mins may apply

1160 psi / 80 bar max

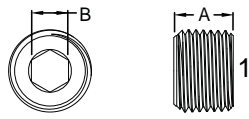
HP Fitting Notes:

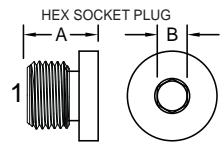
The quick connect fittings on this page are suggested to be used with high pressure nylon tubing listed below or hose & standpipe w/claw groove fittings on page 23.

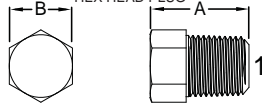
- 1/4" 70420-25
- 4mm 21267
- 6mm 731002173

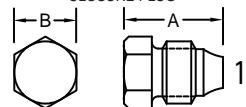
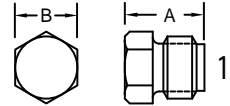
	THREADS		BDI PART #			DIMENSIONS			DRAWINGS
	Male (1)	Steel	Brass	Stainless	TYPE	A	B	COPPER WASHER/ O-RING REQUIRED	
Plugs  HOLLOW HEX PIPE PLUG	5/16-24	—	B3784	—	4	.625"	.312"		TYPE 1 HOLLOW HEX PIPE PLUG 
	5/16-24	—	B3992	—	5	.468"	.312"		
	5/16-24	—	BB3992*	—	5	.468"	.312"		
	5/16-24	—	34496**	—	4	.625"	.312"	X	
	5/16-24	—	—	27336SS	4	.497"	.312"		
	1/16NPT	U119ZC	—	—	1	.312"	.156"		
	1/8NPT	35573-1	—	—	3	.75"	.562"		
	1/8NPT	U119AC	—	UST119AC	1	.312"	.187"		
	7/16-20	64161S001	—	—	2	10mm	6mm	X	
	1/4NPT	35573-2	—	—	3	.437"	.437"		
 HEX SOCKET PLUG	1/4NPT	U119BC	—	—	1	.437"	.25"		TYPE 2 HEX SOCKET PLUG 
	9/16-18	MCS2507	—	—	2	.49"	.25"	X	
	3/8NPT	U119CC	—	—	1	.50"	.312"		
	3/8NPT	—	—	35664	1	.87"	.69"		
	1/2NPT	U119DC	—	—	1	.562"	.375"		
	3/4NPT	U119EC	—	—	1	.625"	.562"		
	1/4BSPP	35009	—	—	3	12.5MM	7MM	X	
	1/8BSPT	19026	—	—	1	8MM	5MM		
	1/4BSPT	AR165	—	—	1	10MM	6MM	X	
	3/8BSPP	741062118	—	—	3			X	
 HEX HEAD PLUG	M8X1	—	15322	—	4	15.87MM	8MM	X	TYPE 3 HEX HEAD PLUG 
	M8X1	—	34497***	—	4	15.37MM	8MM	X	
	M10X1	74106-1164	—	—	2	11MM	5MM	X	
	M10X1	AR1024	—	—	2	12MM	5MM		
	M12X1	AR1025	—	—	2	12MM	5MM		
	M12X1	35008	—	—	2	15MM	17MM	X	
	M14X1.5	—	34773	—	3	10MM		X	
	M16X1.5	45111	—	—	2	15MM		X	
	M22X1.5	22454	—	—	5	20MM	27MM	X	
	M22X1.5	37160****	—	—	5	20MM	27MM	X	
 CLOSURE PLUG									TYPE 4 CLOSURE PLUG 
									TYPE 5 CLOSURE PLUG 

*BAG OF 25 B3992
 **BAG OF 10 B3784
 ***BAG OF 10 15322
 ****Includes 1/4NPSF female tap

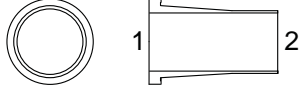
	TUBE	BDI PART #			INFORMATION	DRAWING
	Tube OD (1)	Steel	Brass	TYPE	DRILLED HOLE SIZE (2)	
 Drive Bushings	5/32	-	B3596	REAMED TAPER	.20"	
	5/32	B4067	-	STRAIGHT DRILL	1/4"	
	3/32	-	B5271	REAMED TAPER	9/64"	
	3/32	B4440	-	STRAIGHT DRILL	11/64"	

	TUBE / THREADS		BDI PART #			DIMENSIONS		NOTES	DRAWINGS
	Tube OD (2)	Male (1)	Steel	Brass	Stainless	A	B		
Male Compression Bushings 	3/32	5/16-24	—	B3373	—	.468"	.375"	1	
	3/32	5/16-24	—	BB3373	—	.468"	.375"	1	BAG/25 B3373
	1/8	5/16-24	—	24570	—	.468"	.375"	1	
	1/8	5/16-24	27339	—	27339SS	.36"	.312"	1	
	1/8	5/16-24	—	27337	27337SS	.497"	.312"	2	
	1/8	5/16-24	27340	—	27340SS	.50"	.312"	3	
	5/32	5/16-24	—	B3783	—	.468"	.312"	1	
	5/32	5/16-24	—	BB3783	—	.468"	.312"	1	BAG/25 B3783
	5/32	5/16-24	—	B1371	—	.468"	.375"	1	
	5/32	5/16-24	—	BB1371	—	.468"	.375"	1	BAG/25 B1371
	5/32	5/16-24	—	B3734	—	.468"	.375"	1	ZINC-NICKEL
	3/16	3/8-24	—	B1914	—	.531"	.375"	1	
	3/16	1/8NPSF	U81AA1	U81AA1B	—	.843"	.437"	2	
	1/4	1/8NPSF	U81B1	U81B1B	—	.75"	.437"	2	
	1/4	1/4NPSF	U81B2	—	—	.937"	.562"	2	
	3/8	3/8NPSF	U81D3	U81D3B	—	1.0"	.687"	2	
	4MM	M8X1	73511-5133	15326	—	12MM	8MM	1	
	4MM	M8X1	—	15328C	—	11.9MM	10MM	1	
	4MM	M8X1	—	34494	—	11.9MM	10MM	1	BAG/25 15328C
	6MM	M10X1	34999	—	—	13MM	10MM	1	
	6MM	M10X1	—	22545	—	13MM	11MM	1	
	6MM	1/8BSPT	63422-2261	—	—	21MM	10MM	2	
	6MM	1/8BSPT	—	63422-2241	—	21MM	10MM	2	
	8MM	M12X1	73511-5163	—	—	14MM	12MM	1	
	8MM	M14X1.5	35000	—	—	16MM	14MM	1	
	10MM	3/8BSPT	63422-2211	—	—	33MM	17MM	2	
	10MM	M16X1.5	—	25568	—	20MM	17MM	1	USE W/25677

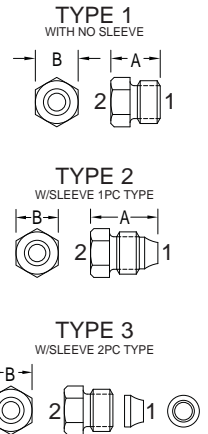



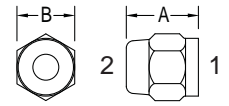

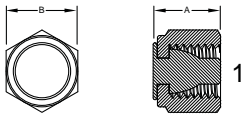

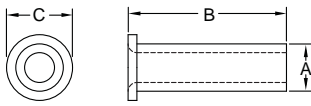
	TUBE / THREADS		BDI PART #			DIMENSIONS		NOTES	DRAWING
	Tube OD (2)	Female (1)	Steel	Brass	Stainless	A	B		
Female Compression Nuts 	3/32	1/4-28	—	B3610	—	.406"	.312"		
	3/32	5/16-24	—	B3312	—	.468"	.375"		
	1/8	5/16-24	—	24448	—	.468"	.375"		
	5/32	5/16-24	—	B1095	—	.468"	.375"		
	5/32	5/16-24	—	B3733	—	.516"	.375"	CHROME	
	3/16	3/8-24	—	B1226	—	.468"	.437"		
	3/16	3/8-24	—	35433	—	.38"	.437"	CAPTIVE SLEEVE	
	3/16	3/8-24	—	BB1226	—	.468"	.437"	BAG/25PCS B1226	
	1/4	7/16-20	—	B10089-1	—	.70"	.56"		
	1/4	7/16-24	—	B6087	—	.437"	.50"		
	5/16	1/2-24	—	B146	—	.437"	.562"		
	5/16	1/2-24	—	35531	—	.45"	.625"	CAPTIVE SLEEVE	
	3/8	9/16-18	—	B10089-3	—	.75"	.69"		
	3/8	9/16-24	—	B6531	—	.468"	.625"		
	3/8	9/16-24	—	35434	—	.42"	.562"	CAPTIVE SLEEVE	
	4MM	M8X1	—	15327	—	.468"	10mm		
	4MM	M8X1	—	34495	—	.468"	10MM	BAG/25PCS 15327	
	4MM	M8X1	-	63422-2341	-	13MM		NUT&SLEEVE FOR ZEE	
	6MM	M12X1.5	AR204	—	—	14.5MM	14MM		
	6MM	M14X1.5	AR1272	—	—	16.5MM	17MM		
	6MM	M10X1	AR194	—	—	11.5MM	12MM		
	8MM	M14X1.5	AR205	—	—	14.5MM	17MM		
	10MM	M16X1.5	AR208	—	—	15.5MM	19MM		

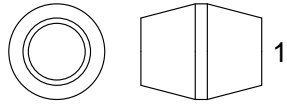

	THREADS		BDI PART #		DIMENSIONS		DRAWING
	Female (1)		Brass		A	B	
	5/16-24		B3478		.57"	.375"	
	5/16-24		A4082		.286"	.375"	

	TUBE	BDI PART #	DIMENSIONS				DRAWING
	Tube OD	#	INSERT O.D. A	LENGTH B	FLANGE O.D. C	CAN BE USED WITH TUBE P.N.	
	5/32	19268	.098"	.315"	.157"	5N25	
	1/4	B144-2	.142"	.737"	.25"-.27"	U428B	
	1/4	B144-3	.157"	.487"	.245"		
	1/4	B144-4	.164"	.647"	.25"	B8598	
	1/4	B144-6	.127"	.479"	.235"	70420	
	1/4	B144-7	.180"	.647"	.245"	B8599	
	1/4	B144-11	.150"	.562"	.218"		
	5/16	20108-1	.232"	.50"		20100	
	5/16	36447	.1875"	.625"	.234"	29942	
	3/8	B144-5	.245"	.844"	.36"	B10067	
	4MM	22585-1	3MM	15.5MM	4MM	5N25-25	
	4MM	AR629	2.7MM	10MM		4N28V	
	6MM	34836	4MM	14MM	5MM	35006	
	6MM	22585-2	4MM	15.5MM	5MM	B10437C	
	6MM	AR1094	4MM	10MM		27490/35006	
	8MM	34837	5MM	14MM	8MM	35007	
	10MM	34838	7.5MM			34825	
	10MM	22585-3	7.5MM	15MM	10MM	34825	
	10MM	35735	6MM	MM	8MM	10N6-BLACK	
	12MM	34839	9MM	15MM	12MM	34826	

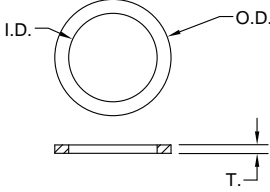

	TUBE	TYPE	BDI PART #			NOTES	DRAWINGS
	Tube OD (1)	#	Steel	Brass	Stainless		
	3/32	1	—	B3313	—		
	3/32	1	—	BB3313	—		B3313 PACK OF 50
	1/8	2	—	27338	—		NYLON TUBING
	1/8	2	—	—	27338SS		NYLON TUBING
	1/8	1	—	24456	—		METAL TUBING
	5/32	1	—	B1061	—		METAL TUBING
	5/32	2	—	B8272	—		NYLON TUBING
	5/32	1	—	BB1061	—		B1061 PACK OF 50
	5/32	2	—	BB8272	—		B8272 PACK OF 50
	3/16	1	—	B1227	—		
	1/4	1	—	B2520	—	METAL TUBING	
	1/4	2	—	B10202	—	NYLON TUBING	
	1/4	3	B10088-1	—	—		
		3/8	1	—	B6532	—	
		3/8	3	B10088-3	—	—	
		4MM	3	73511-1134	—	—	
		4MM	1	—	35001	—	
		4MM	3	23403	—	—	LL SERIES
		4MM	4	—	73511-2711	—	
		6MM	4	—	73511-2721	—	
6MM		3	AR206	—	—	LL SERIES	
6MM		3	73511-1154	—	—	LIGHT SERIES	
6MM		1	—	35002	—	LIGHT SERIES	
	6MM	2	—	22577	—	NYLON TUBING	
	6MM	1	—	B2520C	—	METAL TUBING	
	6MM	1	—	AR938	—	METAL TUBING	
		8MM	3	AR200	—	—	L SERIES
		8MM	3	73511-1164	—	—	LIGHT SERIES
		8MM	1	—	35003	—	LIGHT SERIES
		8MM	3	73511-1224	—	—	HEAVY SERIES
		10MM	3	73511-1234	—	—	
		10MM	1	—	25677	—	USE W/25568
		10MM	3	AR209	—	—	L SERIES

	USED ON		DIMENSIONS			BDI	DRAWING
	Thread Size	I.D.	O.D.	T.	Part Number		
Copper Seals 	M6	6.2MM	9.9MM	1MM	20913-4		
	M8	8.2MM	12.9MM	1MM	20913-6		
	M8	8.2MM	11.4MM	1MM	20913-9		
	M10	10.2MM	13.4MM	1MM	20913-1		
	M10	10.2MM	13.9MM	1MM	20913-2		
	M12	12.2MM	15.4MM	1.5MM	20913-3		
	M16	16MM	20MM	1.85MM	25589-23		
	M16	16.3MM	20MM	1.5MM	23483		
	M22	22.4MM	27MM	1.5MM	25589-7		
	M10 - 1/8BSPP	10.2MM	13.4MM	1MM	72712-1094		
	M10 - 1/8BSPP	10.2MM	13.4MM	1.5MM	25589-2		
	M13	13.4MM	18.8MM	1.5MM	25589-5		
	M14 - 1/4BSPP	14.2MM	17.9MM	1.5MM	35010		
	3/8BSPP	17MM	21MM	1.5MM	72712-1324		
	1/2BSPP	21MM	26MM	1.5MM	72712-1364		
	1BSPP				72712-1624		

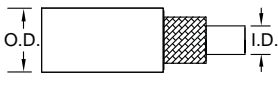
PDI/SLR Bulk Hose & Fittings

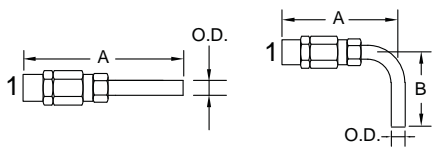
	HOSE		WORKING PRESSURE		BDI PART #	SOLD PER	STD REEL LENGTH	DRAWING
	I.D.	O.D.	PSI	Bar				
	4.1 MM	8.75 MM	3000	200	34962-25	EACH	25'FT	
					34962-164	EACH	164'FT	
	6.4 MM	14.4 MM	2100	140	34964	FT		

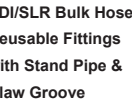
	STAND PIPE SIZE	TYPE	BDI PART #	USE WITH HOSE PART #	DIMENSIONS		DRAWINGS
	O.D.		O.D.	(1)	A	B	
	3/16	STR	29116	34962	58MM	N/A	 <p>Note: Sleeves are Included</p>
	1/4	90 DEG	29220	34962	50MM	32MM	
	1/4	STR	29117	34962	58MM	N/A	
	4MM	STR	29587	34962	64MM	N/A	
	4MM	90 DEG	29585	34962	50MM	32MM	
	6MM	STR	AR1532	34962	64MM	N/A	
	6MM	90 DEG	AR1736	34962	50MM	32MM	
	8MM	STR	AR510	34964	71MM	N/A	

	STAND PIPE SIZE	TYPE	BDI PART #	USE WITH HOSE PART #	DRAWINGS
	O.D.		O.D.		
	1/4	STR	AR5215	34962	 <p>Note: Sleeves are not Included, order separate</p>
		90 DEG	AR5216	34962	
		45 DEG	AR5217	34962	
	6MM	STR	73391-2811	34962	
		90 DEG	73391S008	34962	
		45 DEG	73391S038	34962	
HOSE SLEEVE			73391-3443		

PDI/SLR Assemblies

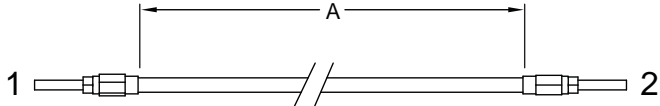
	STAND PIPE SIZE (BOTH ENDS)		HOSE LENGTH	BDI PART #	DRAWING
	O.D. (1 & 2)		INCHES*(A)		
6MM / 8MM O.D. Standpipe Hose Assemblies 	6MM	8		34971-8	
	6MM	10		34971-10	
	6MM	12		34971-12	
	6MM	14		34971-14	
	6MM	16		34971-16	
	6MM	18		34971-18	
	6MM	20		34971-20	
	6MM	22		34971-22	
	6MM	24		34971-24	
	6MM	26		34971-26	
	6MM	28		34971-28	
	8MM	8		34972-8	
	8MM	10		34972-10	
	8MM	12		34972-12	
	8MM	14		34972-14	
	8MM	16		34972-16	
	8MM	18		34972-18	
	8MM	20		34972-20	
	8MM	22		34972-22	
	8MM	24		34972-24	
8MM	26		34972-26		
8MM	28		34972-28		

* PDI Hose length does not include fittings. Assemblies use 34962/34964 hose.

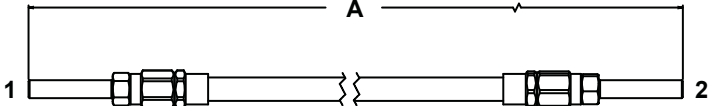
	STAND PIPE SIZE (BOTH ENDS)		HOSE LENGTH	BDI PART #	DRAWING
	O.D. (1 & 2)		INCHES*(A)		
4MM O.D. Standpipe Hose Assemblies 	4MM	8		85225-8	
	4MM	12		85225-12	
	4MM	16		85225-16	
	4MM	20		85225-20	
	4MM	24		85225-24	
	4MM	30		85225-30	
	4MM	36		85225-36	
	4MM	42		85225-42	
	4MM	48		85225-48	
	4MM	54		85225-54	
	4MM	60		85225-60	
	4MM	78		85225-78	
	4MM	90		85225-90	
	4MM	108		85225-108	
	4MM	132		85225-132	
	4MM O.D. Standpipe Hose Assemblies Incl. Spiral Wire	4MM	12		
4MM		16		85225-16A	
4MM		20		85225-20A	
4MM		24		85225-24A	
4MM		30		85225-30A	
4MM		36		85225-36A	
4MM		42		85225-42A	
4MM		48		85225-48A	
4MM		54		85225-54A	
4MM		60		85225-60A	
4MM		66		85225-66A	
4MM		90		85225-90A	
4MM		108		85225-108A	
4MM	132		85225-132A		

* Hose length does include fittings. Assemblies use 34962 hose.

Dualine, Injector & Progressive Hose Assemblies

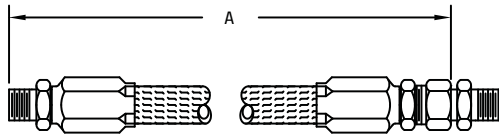
	BDI PART#	HOSE		ENDS		WORKING PRESSURE		DRAWING
		I.D.	"A"	1st	2nd	PSI	Bar	
Medium Pressure Hose Assemblies 	201221	1/4"	24"	1/4NPT	1/4NPT	2750	189	 MEDIUM PRESSURE
	201222	1/4"	30"	1/4NPT	1/4NPT	2750	189	
	201223	1/4"	36"	1/4NPT	1/4NPT	2750	189	
	201224	1/4"	42"	1/4NPT	1/4NPT	2750	189	
	201225	1/4"	48"	1/4NPT	1/4NPT	2750	189	
	201226	1/4"	60"	1/4NPT	1/4NPT	2750	189	
	201227	1/4"	72"	1/4NPT	1/4NPT	2750	189	
	55323	1/4"	240"	1/4NPT	1/4NPT	2750	189	

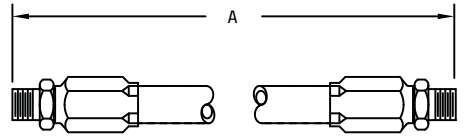
	BDI PART#	HOSE		ENDS		WORKING PRESSURE		DRAWING
		I.D.	"A"	1st	2nd	PSI	Bar	
High Pressure Hose Assemblies 	UX718602036	3/8"	36"	3/8NPT	3/8NPT	4000	275	 HIGH PRESSURE
	UX718602072	3/8"	72"	3/8NPT	3/8NPT	4000	275	

Barrel Pump Hose Assemblies

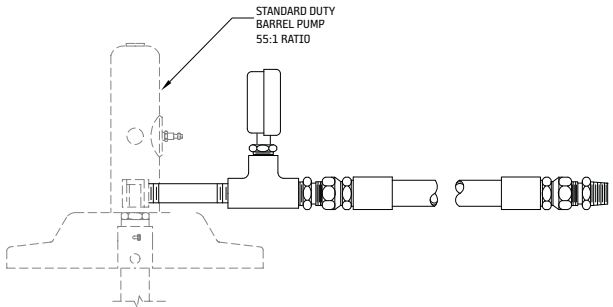
	BDI PART #	HOSE		WORKING PRESSURE		ENDS	LONG	DRAWING
		I.D.	PSI	Bar				
Hose Assemblies for drum pumps with Pressure Gauge 	200275	1/2"	5000	344	3/8NPT	72"	 STANDARD DUTY BARREL PUMP 55:1 RATIO	
	HOS14010B	1/2"	5000	344	3/8NPT	144"		
	55317	1/2"	5000	344	3/8NPT	192"		
	55336	1/2"	5000	344	3/8NPT	300"		
Includes Pressure gauge, tee, nipple, bushing & adapters.								

Specialty Hose Assemblies

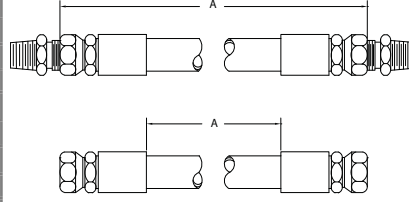
	BDI PART #	HOSE		WORKING PRESSURE		ENDS	TYPE	DRAWING
		I.D.	"A"	PSI	Bar			
Hose Assemblies for drum pumps 	200324	3/4"	72"	1250	86	3/8NPT X 1/2NPT	RELIEF HOSE KIT	
	200306	1/2"	72"	5000	344	3/8NPT X 3/8NPT	LUBE SUPPLY HOSE USED IN 200275	
	55319	1/2"	192"	250	17	1/2NPT X 1/4NPT	AIR SUPPLY HOSE	
	55338	1/2"	300"	250	17	1/2NPT X 1/4NPT	AIR SUPPLY HOSE	
	200325	1/2"	72"	250	17	1/2NPT X 1/4NPT	AIR SUPPLY HOSE	
	200307	3/4"	72"	1250	86	1/2NPT X 1/2NPT	RELIEF HOSE USED IN 200324	
	HOS13907B	1/2"	144"	5000	344	3/4-16 SAE FEMALE(2)	LUBE SUPPLY HOSE USED IN HOS14010B	
	55320	1/2"	192"	250	17	3/4-16 SAE FEMALE(2)	AIR SUPPLY HOSE SIMILAR TO 200513	
	200513	1/2"	72"	250	17	3/4-16 SAE FEMALE(2)	AIR SUPPLY HOSE USED IN 200325	
	55322	1/2"	240"	250	17	3/4-16 SAE FEMALE(2)	AIR SUPPLY HOSE	
	55339	1/2"	300"	250	17	3/4-16 SAE FEMALE(2)	AIR SUPPLY HOSE	
	201369	1/2"	36"	250	17	3/4-16 SAE FEMALE(2)	AIR SUPPLY HOSE	
	55318	1/2"	192"	5000	344	3/4-16 SAE FEMALE(2)	LUBE SUPPLY HOSE SIMILAR 200549	
	55337	1/2"	300"	5000	344	3/4-16 SAE FEMALE(2)	LUBE SUPPLY HOSE SIMILAR 200549	
	200549	1/2"	72"	5000	344	3/4-16 SAE FEMALE(2)	LUBE SUPPLY HOSE USED IN 200306	

Feed Line Hose Assemblies & Fittings

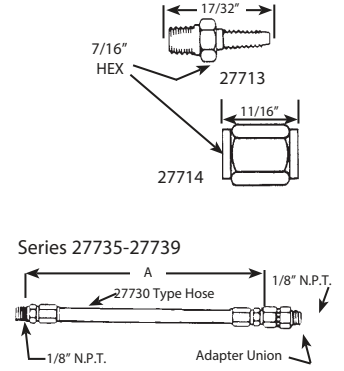
	BDI PART #	CONST.	DESCRIPTION	WORKING PRESSURE		SIZE	DRAWING		
				PSI	Bar				
Hose Assemblies 	27713	STEEL	HOSE STUD	500	34	1/8"NPT MALE X 1/4-28 MALE			
	27714		COUPLING NUT			1/4-28 FEMALE			
	27715	STAINLESS	HOSE STUD			1/8"NPT MALE X 1/4-28 MALE			
	27716		COUPLING NUT			1/4-28 FEMALE			
	27729	HOSE	3/16" I.D. HOSE			25'FT LONG COIL		BULK LENGTH	12"IN
	27730					18"IN			
	27735	1/8"NPT MALE AT ONE END AND SWIVEL ADAPTER UNION 1/8"NPT MALE AT OTHER END							24"IN
	27736								30"IN
	27737								36"IN
	27738								
	27739								

Air Supply Hose Assemblies

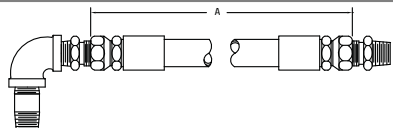
	BDI PART #	HOSE		ENDS		WORKING PRESSURE		DRAWING
		I.D.	"A"	1st	2nd	PSI	Bar	
Air Supply Hose Assemblies 	201502	1/4"	36"	1/2NPT	1/2NPT	250	17	
	55321	1/4"	240"	1/2NPT	1/2NPT	250	17	

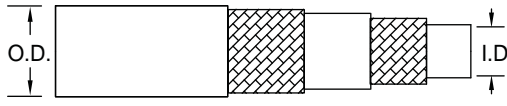
	HOSE		WORKING PRESSURE		BDI PART #	INFORMATION	DRAWING
	I.D.	O.D.	PSI	Bar			
Hose 	3/16	29/64	425	29	U702B		
	3/16	3/8	500	34	27729	25FT LENGTH	
	3/16	3/8	500	34	27730	BULK	
	1/4	.59	5800	400	U7184	SAE100R2	
	1/4	9/16	2750	189	201200	SAE100R1	
	1/4	0.47	3000	206	HOS12125-50 HOS12125-100 HOS12125-500	SAE100R7	
	3/8	.75	4750	327	U7186	SAE100R2	
	1/2	.87	4000	275	U7188	SAE100R2	

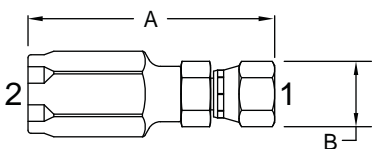
	HOSE	THREAD	BDI PART #		INFORMATION	DIMENSIONS		DRAWING
	I.D. (2)	Female(1)	Steel	Stainless		USE WITH HOSE #	A	
Reusable Hose Fittings: Straight Female Thread SAE(JIC) Swivel X Hose 	1/4	7/16-20	201188	201188SST	201200	2.44"	.562"	
	1/4	7/16-20	85493	—	HOS12125	2.18"	.562"	
	1/4	7/16-20	U43844	35637-1	U7184	2.45"	.562"	
	3/8	9/16-18	U43866	35637-2	U7186	2.74"	.75"	
	3/8	3/4-16	U43886	—	U7186	2.86"	.875"	
	1/2	3/4-16	U43888	35637-3	U7188	3.19"	.875"	

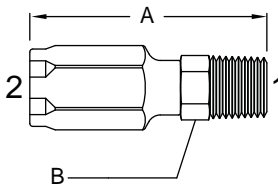
	HOSE	THREAD	BDI PART #		INFORMATION	DIMENSIONS		DRAWING
	I.D. (2)	Male(1)	Steel	USE WITH HOSE #		A	B	
Reusable Hose Fittings: Straight Male Thread NPT X Hose 	3/16	1/8NPT	U404AB1	U702B	1.73"	.436"		
	1/4	1/8NPT	201185	201200				
	1/4	1/4NPT	201186	201200	2.42"	.562"		
	1/4	3/8NPT	201187	201200				
	1/4	1/8NPT	U43724	U7184	2.20"	.562"	RIGID	
	1/4	1/4NPT	U43744	U7184	2.38"	.562"	RIGID	
	3/8	3/8NPT	U43766	U7186	2.58"	.75"	RIGID	
	1/2	1/2NPT	U43788	U7188	3.11"	.875"	RIGID	

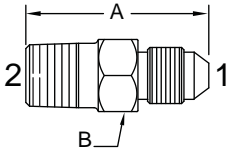
	THREADS		BDI PART #		DIMENSIONS		DRAWING
	Male (1)	Male (2)	Steel	Stainless	A	B	
Straight Adapter Male Thread SAE(JIC) X Male NPT 	1/2-20	1/4NPT	U43145	—	1.42"	.562"	
	1/2-20	1/8NPT	U43125	—	1.21"	.562"	
	7/16-20	3/8NPT	U43164	35638-3	1.44"	.75"	
	7/16-20	1/4NPT	U43144	35638-1	1.42"	.562"	
	7/16-20	1/8NPT	U43124	35638-5	1.21"	.50"	
	9/16-18	1/2NPT	U43186	—	1.68"	.875"	
	9/16-18	3/8NPT	U43166	35638-4	1.43"	.75"	
	9/16-18	1/4NPT	U43146	35638-2	1.43"	.625"	
	9/16-18	1/8NPT	35575-1	35638-8	1.24"	.625"	
	3/4-16	3/4NPT	U431128	—	1.85"	1.125"	
	3/4-16	1/2NPT	U43188	—	1.78"	.875"	
	3/4-16	3/8NPT	U43168	35638-7	1.53"	.812"	
	3/4-16	1/4NPT	U43148	35638-6	1.53"	.812"	

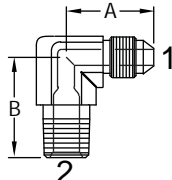
	THREADS		BDI PART #		DIMENSIONS		DRAWING
	Male (1)	Male (2)	Steel	Stainless	A	B	
90 Degree Adapter Male Thread SAE(JIC) X Male NPT 	7/16-20	1/4NPT	35528-1	35636-1	1.05"	1.09"	
	7/16-20	3/8NPT	35528-3	35636-3	1.13"	1.22"	
	7/16-20	1/8NPT	35528-5	35636-5	.89"	.78"	
	9/16-18	1/4NPT	35528-2	35636-2	1.06"	1.09"	
	9/16-18	3/8NPT	35528-4	35636-4	1.14"	1.22"	
	9/16-18	1/8NPT	35528-8	35636-8	1.06"	.90"	
	3/4-16	1/4NPT	35528-6	35636-6	1.25"	1.22"	
	3/4-16	3/8NPT	35528-7	35636-7	1.25"	1.22"	

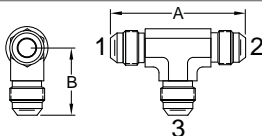
	THREADS			BDI PART #		DIMENSIONS		DRAWING
	Male (1)	Male (2)	Male (3)	Steel	Stainless	A	B	
Tee Male Thread SAE(JIC)37 	7/16-20	7/16-20	7/16-20	35582-1	-	.84"	1.46"	
	9/16-18	9/16-18	9/16-18	35582-2	-	28MM	40MM	
	3/4-16	3/4-16	3/4-16	35582-3	-			

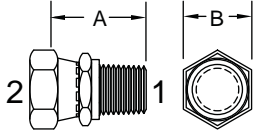
	THREADS		BDI PART #		DIMENSIONS		DRAWING
	Male (1)	Female (2)	Steel	Stainless	A	B	
Straight Male Thread X Female Thread Swivel 	1/8NPT	1/8NPSM	B10275-1*	-	1.09"	.562"	
	1/8NPT	1/8NPT	32382-1*	-	.85"	.562"	
	1/4NPT	1/4NPT	37271**	-	1.77"	.562"	
	1/4NPT	1/4NPSM	B10275-3*	-	1.43"	.687"	

* SWIVEL STOPS WHEN TIGHT **45 DEG

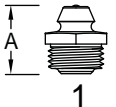
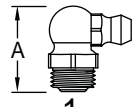
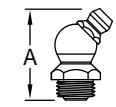
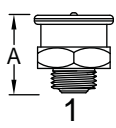



	THREAD	TYPE	BDI PART #	DIMENSIONS	DRAWINGS
	Male (1)			A	
Zerk Grease Fittings 	1/4-28	STR SHORT	F651	.53"	Straight 
	1/4-28	STR MED	F652	.69"	
	1/4-28	STR LNG	F653	1.12"	
	1/4-28	90 DEG	F656	.75"	
	1/4-28	45 DEG	F657	.81"	90 Degree 
	1/8NPT	STR	15332-1*	.86"	
	1/8NPT	STR	15332-3**	.86"	45 Degree 
	1/8NPT	30 DEG	F671	.843"	
	1/8NPT	65 DEG STR	F672	.843"	Button Head 
	1/8NPT	90 DEG	15332-2*	.97"	
	1/8NPT	90 DEG	F673	.843"	
	1/8NPT	STR SHORT	F674	.687"	
	1/8NPT	65 DEG LNG	F675	.531"	
	1/8NPT	45 DEG	F678	.890"	
	1/8NPT	STR LNG	F679	1.75"	
	1/8NPT	STD BUTTONHEAD	F1290	.75"	
	1/4NPT	STR	F687	.875"	
	1/4NPT	65 DEG	F689	.968"	
	1/4NPT	STD BUTTONHEAD	F1291	.828"	
	1/4NPT	GIANT BUTTONHEAD	F1292	1.25"	
	3/8NPT	GIANT BUTTONHEAD	F1293	1.312"	
	1/8BSPT	STR	19448	15MM	
	1/4BSPT	STR	19449	19MM	
	1/4BSPT	90 DEG	20870-1	22MM	
	1/4BSPT	45 DEG	20669-2	23MM	
	1/4 DRIVE	STR	F662	.546"	
	3/16 DRIVE	STR	F666	.515"	
	5/16 DRIVE	STR	F668	.546"	
	M6X1	STR	F691	.593"	
	M6X1	45 DEG	F694	.812"	
	M6X1	90 DEG	F697	.75"	
	M8X1	STR	F692	.625"	
M8X1	45 DEG	F695	.812"		
M8X1	90 DEG	F698	.75"		
M10X1	45 DEG	20669-1	25MM		

* Leakproof 3K psi

**Leakproof High Pressure
10Kpsi

	TUBE		BDI			# OF			INFO	DIMENSIONS			DRAWINGS
	O.D.	PART #	# OF TUBES	MNTG HOLES	TYPE	A	B	MNTG HOLE					
	3/32	B3570	1	1	1	7/16"	.50"	.14"	.196"	TYPE 1 			
	3/32	34486	1	1	1	BAG 25 B3570	.50"	.14"	.196"				
	1/8	27820-1	1	1	1	NOT SUPPLIED W/SCREWS	.562"	.125"	.156"				
	1/8	27820-2	2	2	6	NOT SUPPLIED W/SCREWS	.312"	.187"	.156"				
	1/8	27820-3	3	2	6	NOT SUPPLIED W/SCREWS	.437"	.187"	.156"				
	1/8	27820-4	4	2	6	NOT SUPPLIED W/SCREWS	.562"	.187"	.156"				
	1/8	27820-5	5	2	6	NOT SUPPLIED W/SCREWS	.687"	.187"	.156"	TYPE 2 			
	1/8	27821-2	2	2	6	STAINLESS, NOT SUPPLIED W/SCREWS	.312"	.187"	.156"				
	1/8	27821-5	5	2	6	STAINLESS, NOT SUPPLIED W/SCREWS	.687"	.187"	.156"				
	5/32	A2435	1	1	1	1/2"	.70"	.20"	.196"				
	5/32	A2764	1	1	1	11/32"	.84"	.25"	.265"				
	5/32	B3539	2	1	2	5/16"	.84"	.25"	.196"				
	5/32	B3567	2	1	2	13/16"	1.0"	.25"	.265"	TYPE 3 			
	5/32	B7535	3-5	1	3	1"	1.1"	.25"	.196"				
	5/32	34487	1	1	1	BAG 25 A2435	.70"	.20"	.196"				
	5/32	34488	1	1	1	BAG 25 A2764	.84"	.25"	.265"				
	5/32	34489	2	1	2	BAG 25 B3539	.84"	.25"	.196"				
	5/32	34490	2	1	2	BAG 25 B3567	1.0"	.25"	.265"				
	5/32	34491	3-5	1	3	BAG 25 B7535	1.1"	.25"	.196"	TYPE 4 			
	3/16	U301A1	1	1	1	W/ 1/4-20X3/8"LG SCREW	1.06"	.25"	.281"				
	3/16	U301A2	2	1	3	W/ 1/4-20X3/8"LG SCREW	1.25"	.25"	.281"				
	3/16	U301A3	3	1	3	W/ 1/4-20X3/8"LG SCREW	1.437"	.25"	.281"				
	1/4	35476	1	1	1	1/2"	1.0"	.312"	.218"				
	1/4	B10349-5	1	2	-	WELD BASE	1.531"	1.312"					
	1/4	34492	1	1	1	BAG 25 35476	1.0"	.312"	.218"	TYPE 5 			
	1/4	U301B1	1	1	1	W/ 1/4-20X3/8"LG SCREW	1.125"	.312"	.281"				
	1/4	U301B2	2	1	3	W/ 1/4-20X3/8"LG SCREW	1.375"	.312"	.281"				
	1/4	U301B3	3	1	3	W/ 1/4-20X3/8"LG SCREW	1.625"	.312"	.281"				
	1/4	U1301B4	4	2	6	W/2PCS 1/4-20X3/8"LG SCREW	1.125"	.312"	.281"				
	1/4	U1301B6	6	2	6	W/2PCS 1/4-20X3/8"LG SCREW	1.625"	.312"	.281"				
	1/4	36505	1	1	5	STAINLESS STEEL	.8125"	.312"	.203"	TYPE 6 			
	1/4	35448-1-25	1	1	5	RUBBER DIP-BAG 25	1.15"	.39"	.281"				
	3/8	B6508	1	1	1	1/2"	1.0"	.437"	.218"				
	3/8	34493	1	1	1	BAG 25 B6508	1.0"	.437"	.218"				
	3/8	U301D1	1	1	1	W/ 1/4-20X3/8"LG SCREW	1.25"	.437"	.281"				
	3/8	U301D2	2	1	3	W/ 1/4-20X3/8"LG SCREW	1.625"	.437"	.281"				
	3/8	U1301D3	3	2	6	W/2PCS 1/4-20X3/8"LG SCREW	1.25"	.437"	.281"	TYPE 5 			
	3/8	U1301D4	4	2	6	W/2PCS 1/4-20X3/8"LG SCREW	1.625"	.437"	.281"				
	3/8	U1301D6	6	2	6	W/2PCS 1/4-20X3/8"LG SCREW	2.375"	.437"	.281"				
	3/8	35448-2-25	1	1	5	RUBBER DIP-BAG 25	1.55"	.525"	.406"				
1/2	U301E1	1	1	1	W/ 1/4-20X3/8"LG SCREW	1.25"	.562"	.281"					
1/2	U1301E2	2	2	6	W/2PCS 1/4-20X3/8"LG SCREW	1.125"	.562"	.281"					
1/2	35448-3-25	1	1	5	RUBBER DIP-BAG 25	1.70"	.714"	.406"	TYPE 6 				
19/32	B10276-2	1	1	5	HOSE .515-.590	45MM	22MM	.406"					
5/8	U301F1	1	1	1	W/ 1/4-20X3/8"LG SCREW	1.437"	.687"	.281"					
5/8	35448-4-25	1	1	5	RUBBER DIP-BAG 25	1.83"	.84"	.406"					
3/4	35448-5-25	1	1	5	RUBBER DIP-BAG 25	2.00"	1.00"	.406"					
7/8	35448-6-25	1	1	5	RUBBER DIP-BAG 25								
3/4	35448-7-10	1	1	5	RUBBER DIP-BAG 10				TYPE 5 				
4MM	73573-4114	1	1	1		20MM	5.5MM	5.5MM					
5.5-7MM	34499	1	1	1	BAG 25 73572-3234	38MM	14MM	6.6MM					
5.5-7MM	73572-3234	1	1	1		38MM	14MM	6.6MM					
7-9MM	35011	1	1	1		40MM	16MM	6.6MM					
7-9MM	35377	1	1	1	BAG 25PCS 35011	40MM	16MM	6.6MM					
7-9MM	73573-3134	1	2	4		48MM	15MM	6.6MM	TYPE 6 				
7-9MM	34758	1	2	4	BAG 10PCS 73573-3134	50MM	15MM	6.6MM					
N/A	U240G2	N/A	N/A	-	1/4-20X3/8"LG SCREW	-	-	-					

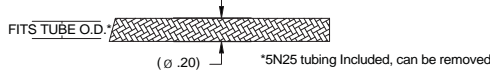
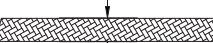

	TUBE O.D.	TUBE WALL	BDI PART #	WORKING PRESSURE		MATERIAL	COLOR	SOLD PER	STD REEL LENGTH	NOTES
				PSI	BAR					
 <p>NOTE: If listed as "EACH" in SOLD PER Column then tubing is only sold in the listed reel lengths.</p>	3/32	.020	3N20	404	27.75	Nylon	Natural	FT	250 FT	
	1/8	.031	26221	500	34.5	Nylon	Natural	FT	250 FT	
		.026	26079	625	43	Nylon	Natural	FT	500 FT	
		.026	27722	625	43	Nylon	Black	EACH	25 FT	
		.026	27389	625	43	Nylon	Black	EACH	100 FT	
		.031	20295	85	5.75	Polyurethane	Clear	FT	500 FT	
	5/32	.025	19230	250	17.25	Nylon	Black	FT	250 FT	
		.025	19230-RD	250	17.25	Nylon	Red	FT	250 FT	
		.025	19230-BU	250	17.25	Nylon	Blue	FT	250 FT	
		.025	19230-BR	250	17.25	Nylon	Brown	FT	250 FT	
		.025	19230-YW	250	17.25	Nylon	Yellow	FT	250 FT	
		.025	19230-GN	250	17.25	Nylon	Green	FT	250 FT	
		.025	5N25-25	300	17.25	Nylon	Natural	EACH	25 FT	
		.025	5N25-250	300	17.25	Nylon	Natural	EACH	250 FT	
		.035	21267	500	34.5	Nylon	Black	FT	250 FT	UV HIGH PRESSURE
		.055	5N55	500	34.5	Nylon	Natural	FT	250 FT	
		.055	5N55-25	500	34.5	Nylon	Natural	EACH	25 FT	
		.055	5N55-250	500	34.5	Nylon	Natural	EACH	250 FT	
		.055	5N55B	500	34.5	Nylon	Black	FT	250 FT	
		.055	5N55B-25	500	34.5	Nylon	Black	EACH	25 FT	
		.055	5N55B-250	500	34.5	Nylon	Black	EACH	250 FT	
	3/16	.024	6N24	250	17.25	Nylon	Natural	FT	250 FT	
		.046	B10271-1	500	34.5	Nylon	Natural	FT	250 FT	
		.038	U428A	625	43	Nylon	Natural	FT	1000 FT	
		.046	B10271-4	500	34.5	Nylon	Black	FT	250 FT	
		.044	35451	500	34.5	Nylon	Black/Red/Blue	FT		3-tube bundle
		.046	35648	500	34.5	Nylon	Black	EACH	15 FT	NLGI #0 PRE FILLED
		.046	35601	500	34.5	Nylon	Black	EACH	20 FT	NLGI #0 PRE FILLED
		.044	35649	500	34.5	Nylon	Black/Red	EACH	15 FT	2-tube bndl NLGI#0 PRE FILLED
		.044	35602	500	34.5	Nylon	Black/Red	EACH	20 FT	2-tube bndl NLGI#0 PRE FILLED
		.044	35650	500	34.5	Nylon	Black/Red/Blue	EACH	15 FT	3-tube bndl NLGI#0 PRE FILLED
	1/4	.062	70420-25	870	60	Nylon	Black	EACH	25 FT	UV HIGH PRESSURE
		.062	70420-325	870	60	Nylon	Black	EACH	325 FT	UV HIGH PRESSURE
		.040	B8598	100	7	Polyethylene	Clear	FT	500 FT	
		.035	B8599	375	25.75	Nylon	Natural	FT	250 FT	
		.062	34211	500	34.5	Nylon	Natural	FT	250 FT	
		.035	8N30	425	29.25	Nylon	Natural	FT	250 FT	
		.050	U428B	625	43	Nylon	Natural	FT	500 FT	
		.062	35127	500	34.5	Nylon	Black	EACH	25 FT	NLGI#0 PRE FILLED
		.062	37533	500	34.5	Nylon	Black	EACH	25 FT	NLGI#1 PRE FILLED
		5/16	.040	20100	312	21.5	Nylon	Natural	FT	250 FT
	.075		U428D	625	43	Nylon	Natural	FT		
	3/8	.075	35543	625	43	Nylon	Black	FT		
	4MM	.75MM	4N25W			Polyurethane	Clear	MT	25 M	
1MM		27490	275	19	Nylon	White	FT			
6MM	1MM	35006	500	34.5	Nylon	Black	FT			
	1MM	B10437C	500	34.5	Nylon	Natural	FT			
	1.5MM	6N3B	471	32.5	Nylon	Natural	FT			
	1.5MM	6N3G-25	471	32.5	Nylon	Natural	EACH	25 M	GREASE FILLED	
	1.5MM	731002173	1305	90	Nylon	Black	MT	100 M	UV HIGH PRESSURE	
	1MM	35461	101	7	Polyurethane	Clear	FT	100 M		
8MM	1.5MM	29942	565	39	Nylon	Black	FT	25 M		
10MM	2MM	10N6-BLACK	600	41.25	Nylon	Black	FT	25 M		
12MM	1.5MM	34826	90	6.25	Nylon	Natural	FT	25 M		

PROTECTION ITEMS	TUBE O.D.	BDI PART #	NOTES	DRAWINGS
 <p>Spring Cover for Nylon Tubing</p>	4MM - 5/32	20111	PER FOOT	 <p>FITS TUBE O.D.   *tubing Not Included.</p>
	5/16	20107		
 <p>Wire Braid Cover for Nylon Tubing</p>	4MM - 5/32	15344	PER FOOT	 <p>FITS TUBE O.D.  (ø .20) *5N25 tubing Included, can be removed.</p>

	TUBE O.D.	TUBE WALL	BDI PART #	MATERIAL	STANDARD		NOTES
					LENGTH	SOLD PER	
 <p>NOTE: If listed as "EACH" in SOLD PER Column then tubing is only sold in the listed reel lengths.</p>	3/32	.022	3C22	COPPER	12'	FT	
	1/8	.030	4C30	COPPER	50'	EACH	
	5/32	.025	5B25	BRASS	12'	FT	
		.025	32196	COPPER	50'	EACH	
		.055	5C55	COPPER	12'	FT	
		.01	85096	STAINLESS STEEL	50'	EACH	304SS
	3/16	.030	U424C3-50	COPPER	50'	EACH	
	1/4	.030	U424C4-50	COPPER	50'	EACH	
		.035	7914035304WSS	STAINLESS STEEL	20'	FT	304SS
		.028	27721	STEEL	25'	EACH	
		.035	U424E4	STEEL	16'-24'	IN	
	5/16	.032	10C32	COPPER	12'	FT	
	3/8	0.032	U424C6-50	COPPER	50'	EACH	
		.049	7938049304WSS	STAINLESS STEEL	20	FT	304SS
		.049	U424E6	STEEL	20'	FT	
	1/2	.065	55312	STAINLESS STEEL	-	FT	316SS
		0.049	55847	STAINLESS STEEL	-	IN	304SS
	3/4	0.065	55848	STAINLESS STEEL		IN	304SS
	6MM	1MM	21431-6	COPPER	12'	FT	
		1MM	25712	COPPER	12'	FT	
1MM		73100-1234	STEEL		FT		

Note: Most metal tubing is normally coiled for shipping. Straight lengths available in some sizes. Specify on order or contact customer service.

	TUBE	BDI	INCLUDES								
	O.D.	PART #	10'-FT	12'-FT	25 PCS	25 PCS	25 PCS	25 PCS	10 PCS	8 PCS	8 PCS
Tube Service Kit	5/32	K1079	5N25	5C25	B1371	B1095	B1061	B8272	A2435	B3784	A2899

	O.D.	BDI PART #	COLOR	MATERIAL	NOTES
 <p>Split Loom</p>	1/4	35419-1	Black	Polyethylene	100ft coils
	1/2	35419-2	Black	Polyethylene	100ft coils
	3/4	35419-3	Black	Polyethylene	100ft coils
	1	35419-4	Black	Polyethylene	100ft coils
 <p>Spiral Wrap</p>	1/2	35645-100	Black	Polyethylene	3/8" to 4" Bundling Range, 100'FT Roll
	1	35646-75	Black	Polyethylene	1" to 7" bundling Range, 75'FT Roll

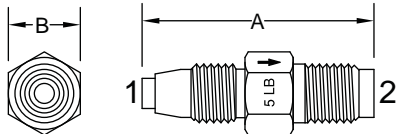
(FLOW→)	OPENING		THREADS		BDI PART #	DIMENSIONS		DRAWING
	PRESSURE	Male (1)	Male (2)	A		B		
Check Valve Junction Mounted 	5 LBS	5/16-24	5/16-24	B3003	1.20"	.375"		
	10 LBS	5/16-24	5/16-24	B3363	1.20"	.375"		
	20 LBS	5/16-24	5/16-24	B3251	1.20"	.375"		
	50 LBS	5/16-24	5/16-24	B5146	1.20"	.375"		

Note: Outlet 5/16-24 thread for 5/32 diameter tubing connection. Use Compression Nut B1095 and Compression Sleeve B1061 listed on pages 16/17.

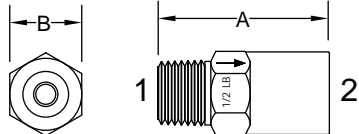
(FLOW→)	OPENING		THREADS		BDI PART #	DIMENSIONS		DRAWING
	PRESSURE	Male (1)	Female (2)	A		B		
Check Valve Adapter Type 	2 LBS	1/8NPT	5/16-24	B3815	1.0"	.437"		
	5 LBS	1/8NPT	5/16-24	B3905	1.0"	.437"		
	10 LBS	1/8NPT	5/16-24	B3906	1.0"	.437"		
	20 LBS	1/8NPT	5/16-24	B4450	1.0"	.437"		
	50 LBS	1/8NPT	5/16-24	B4960	1.0"	.437"		
	2 LBS	1/8NPT	1/8NPTF	B5627	1.0"	.50"		
	5-12 LBS	1/8NPT	1/8NPTF	U1975A1*	1.47"	.50"		
	5-12 LBS	1/8NPT	1/8NPTF	U1975B1*	1.38"	.50"		
	250 LBS	1/8NPT	1/8NPSF	37159**	1.27"	14.2mm		

* 2500PSI PROOF PRESSURE. (Can be used with U81 bushing to connect tubing to female. A1=3/16T B1=1/4")
 ** STEEL, 5000PSI MAX

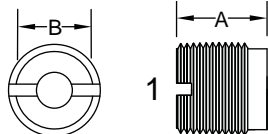
(FLOW→)	OPENING		THREAD	BDI PART #	NOTES	DIMENSIONS		DRAWING
	PRESSURE	Male (1)	A			B		
Check Valve Flush Mounted 	1/2 LB	7/16-20 NF	A3889	USE GASKET A3772	.468"	.362"		
	1/2 LB	1/2-20	B3674	USE GASKET A4191	.468"	.43"		

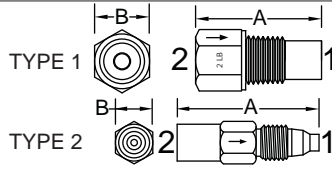
(FLOW→)	OPENING		THREADS		BDI PART #	DIMENSIONS			DRAWINGS
	PRESSURE	Female (2)	Male (1)	A		B	TYPE		
Check Valve Insert 	2 LBS	5/16-24	1/8NPT	B4301	.875"	.437"	1		
	5 LBS	5/16-24	1/8NPT	B3454	.875"	.437"	1		
	10 LBS	5/16-24	1/8NPT	B3874	.875"	.437"	1		
	20 LBS	5/16-24	1/8NPT	B4023	.875"	.437"	1		
	1 LB	5/16-24	5/16-24	B6999*	1.2"	.375"	2		
	10 LB	5/16-24	5/16-24	20883*	1.2"	.375"	2		

* JUNCTION MOUNT

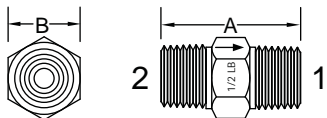
(FLOW→)	OPENING		THREADS		BDI PART #	DIMENSIONS		DRAWING
	PRESSURE	Male (1)	Male (2)	A		B		
Check Valve Connector 	1/2 LB	1/8NPT	1/8NPT	B5290	.875"	.437"		
	2 LBS	1/8NPT	1/8NPT	B4052	.875"	.437"		
	5 LBS	1/8NPT	1/8NPT	B4942	.875"	.437"		
	10 LBS	1/8NPT	1/8NPT	B4943	.875"	.437"		
	20 LBS	1/8NPT	1/8NPT	B4944	.875"	.437"		

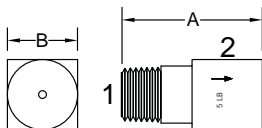
(FLOW→)	OPENING		THREADS		BDI PART #	DIMENSIONS		DRAWING
	PRESSURE	Male (1)	Female (2)	A		B		
Check Valve 90 Degree Connector 	2 LBS	1/8NPT	1/8NPT	B3833	1.0"	.50"		
	5 LBS	1/8NPT	1/8NPT	B3907	1.0"	.50"		
	10 LBS	1/8NPT	1/8NPT	B3908	1.0"	.50"		
	2 LBS	1/8NPT	1/8NPT	B6802	1.0"	.50"		

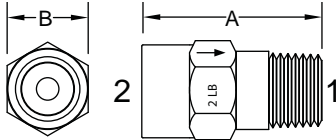
(FLOW→)	OPENING		THREADS		BDI PART #	DIMENSIONS		DRAWING
	PRESSURE	Male (1)	Female (2)	A		B		
	2 LBS	1/8NPT	1/8NPT	B5892	.937"	.50"		
	2 LBS	1/8NPT	5/16-24	B7702	1.0"	.437"		
	10 LBS	1/8NPT	5/16-24	B6091	1.0"	.437"		



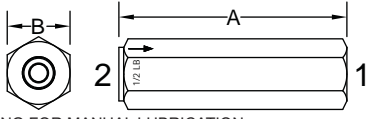



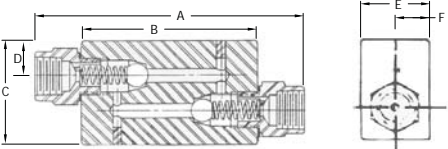

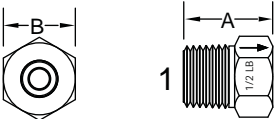



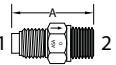

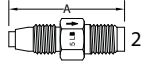

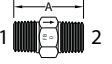

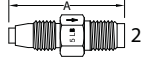
Note: Valves are ball type with flow capacity of 100cc/minute maximum. Tolerance of valve opening pressure is ±10%. Valves with hexagon or square bodies are stamped with the nominal opening pressure and arrow indicating direction of flow.

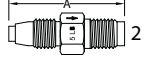
(FLOW→)	OPENING		THREADS		BDI PART#	DIMENSIONS		DRAWING
	PRESSURE	Female(1)	Female(2)	A		B		
	1.5 - 2 LBS	1/4NPT	1/4NPT	U1972B	2.375"	.75"		
	1.5 - 2 LBS	1/4NPT	1/4NPT	U1972B1*	2.375"	.75"		
	5 LBS	3/8NPT	3/8NPT	35677-1	3.0"	1.0"		
	65 LBS	3/8NPT	3/8NPT	35677-2	3.0"	1.0"		

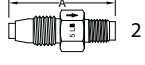

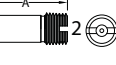

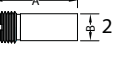

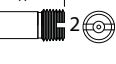

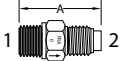

* HAS GREASE FITTING FOR MANUAL LUBRICATION

	BDI PART #	THREADS		DIMENSIONS						DRAWING
		Female (1)	Female (2)	A	B	C	D	E	F	
2-Way Line Check Oil Dualine Systems	U1929D	1/2NPTF	1/2NPTF	5.62"	3.5"	2.25"	0.68"	1.5"	0.75"	
-Proof Pressure 6000 PSI										
-Cracking Pressure 110-120 PSI Avg.										

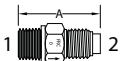
(FLOW→)	OPENING		THREAD	BDI PART #	DIMENSIONS		DRAWING
	PRESSURE	Male (1)			A	B	
	1-5 PSI	1/8NPT		U962B	.484"	.437"	
	50 PSI	1/8NPT		B4974	.625"	.437"	
	75 PSI	1/8NPT		B9943	.688"	.437"	
	100 PSI	1/8NPT		B6898-1	.688"	.437"	
	130 PSI	1/8NPT		B6898	.688"	.437"	
	175 PSI	1/8NPT		B6965	.688"	.437"	
	200 PSI	1/8NPT		B5643	.688"	.437"	
	270 PSI	1/8NPT		B3993	.688"	.437"	
	300 PSI	1/8NPT		19142	.688"	.437"	
	400 PSI	1/8NPT		23232	.688"	.437"	
	450 PSI	1/8NPT		19139	.688"	.437"	
	600 PSI	1/8NPT		29605	23MM	11MM	
	725 PSI	1/8NPT		29541	23MM	11MM	
	1000 PSI	1/8NPT		29183	23MM	11MM	

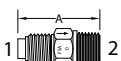
METER UNITS		FLOW	BDI PART	THREADS (FLOW→)		DIMENSIONS		DRAWINGS
TYPE	RATE	#	Inlet(1)	Outlet(2)	A	B		
ASA 	3/0	17841-3/0	M8X1* (5/32 or 4mm tube)	1/8BSPT	24MM	10MM	 	
	00	17841-00						
	0	17841-0						
	1	17841-1						
	2	17841-2						
	3	17841-3						
	4	17841-4						
AJB 	3/0	15323-3/0	M8X1	M8X1* (5/32 or 4mm tube)	30.5MM	10MM	 	
	00	15323-00						
	0	15323-0						
	1	15323-1						
	2	15323-2						
	3	15323-3						
	4	15323-4						
5	15323-5							
FB 	3/0	B8724	1/8NPT	1/8BSPT	53/64	7/16	 	
	00	B8725						
	0	B8452						
	1	B8726						
	2	B8727						
	3	B8728						
	4	B8729						
5	B8730							
FJB 	3/0	B6548	5/16-24	5/16-24* (5/32 or 4mm tube)	1-7/32	3/8	 	
	00	B2494						
	0	B2495						
	1	B2496						
	2	B2497						
	3	B2498						
	4	B2499						
5	B2500							
FJC 	3/0	B7267	5/16-24	5/16-24* (3/32 tube)	1-7/32	3/8	 	
	00	B3314						
	0	B3315						
	1	B3316						
	2	B3317						
	3	B3318						
	4	B3319						
5	B3320							
FJD 	3/0	B6085	5/16-24	1/4-28* (3/32 tube)	1-1/8	5/16	 	
	00	B3773						
	0	B3774						
	1	B3775						
	2	B3776						
	3	B3777						
	4	B3778						
5	B3779							
FKA 	3/0	B7271	—	1/8NPT	29/32	9/32	 	
	00	B3913						
	0	B3914						
	1	B3915						
	2	B3916						
	3	B3917						
	4	B3918						
5	B3919							
FKB 	3/0	B7273	1/8NPT	—	29/32	9/32	 	
	00	B3980						
	0	B3981						
	1	B3982						
	2	B3983						
	3	B3984						
	4	B3985						
5	B3986							
FKD 	3/0	B8878	—	1/8BSPT	29/32	9/32	 	
	00	B8870						
	0	B8871						
	1	B8872						
	2	B8873						
	3	B8874						
	4	B8875						
5	B8876							

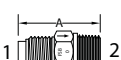
* See page 18-19 for tubing connections.

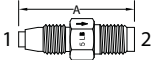
METER UNITS		FLOW	BDI PART	THREADS (FLOW→)		DIMENSIONS		DRAWINGS
TYPE	RATE	#	Inlet(1)	Outlet(2)	A	B		
FRA 	3/0	B7265	1/8NPT	5/16-24* (5/32 or 4mm tube)	1	3/8	 	
	00	B2559						
	0	B3215						
	1	B3216						
	2	B3217						
	3	B3218						
	4	B3219						
FRC 	3/0	B7269	1/8NPT	5/16-24* (3/32 tube)	1	3/8	 	
	00	B3579						
	0	B3580						
	1	B3581						
	2	B3582						
	3	B3583						
	4	B3584						
FSA 	3/0	B6526	5/16-24* (5/32 or 4mm tube)	1/8NPT	61/64	3/8	 	
	00	B1620						
	0	B1083						
	1	B1084						
	2	B1085						
	3	B1086						
	4	B1087						
FSB 	3/0	B8717	5/16-24* (5/32 or 4mm tube)	1/8BSPT	61/64	7/16	 	
	00	B8718						
	0	B8455						
	1	B8719						
	2	B8720						
	3	B8721						
	4	B8722						
MJ 	00	B8042	5/16-24	5/16-24* (1/8" tube)	1-7/32	3/8	 	
	1	B8043						
	2	B8044						
	5	B9514						









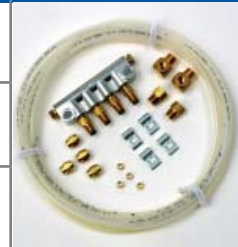

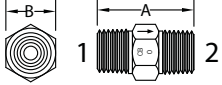

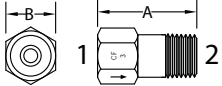
* See page 18-19 for tubing connections.

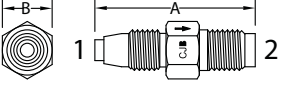
METER UNITS		FLOW	BDI PART	THREADS (FLOW→)		DIMENSIONS			DRAWINGS
TYPE	RATE	#	Inlet(1)	Outlet(2)	A	B	C		
FT 	3/0	B6529	1/8NPT	1/8NPT	53/64	3/8	-	 	
	00	B1398							
	0	B1112							
	1	B1113							
	2	B1114							
	3	B1115							
	4	B1116							
FTA 	3/0	B6549	5/16-24(2)* (5/32 or 4mm tube)	1/8NPT	1-3/8	3/8	1-1/8	 	
	00	B1524							
	0	B1071							
	1	B1072							
	2	B1073							
	3	B1074							
	4	B1075							
FTB 	3/0	B6550	5/16-24(3)* (5/32 or 4mm tube)	1/8NPT	1-3/4	3/8	1-1/8	 	
	00	B1528							
	0	B1077							
	1	B1078							
	2	B1079							
	3	B1080							
	4	B1081							
FTC 	3/0	B6551	5/16-24(2)* (5/32 or 4mm tube)	1/8NPT	1-3/4	3/8	15/16	 	
	00	B1530							
	0	B1098							
	1	B1099							
	2	B1100							
	3	B1101							
	4	B1102							
FTD 	3/0	B6552	5/16-24(2)* (5/32 or 4mm tube)	1/8NPT	1-3/8	3/8	15/16	 	
	00	B1532							
	0	B1106							
	1	B1107							
	2	B1108							
	3	B1109							
	4	B1110							
FTG 	3/0	B6553	5/16-24(3)* (5/32 or 4mm tube)	1/8NPT	1-3/8	3/8	1-1/8	 	
	00	B2759							
	0	B2760							
	1	B2761							
	2	B2762							
	3	B2763							
	4	B2764							
FTH 	3/0	B6554	5/16-24(4)* (5/32 or 4mm tube)	1/8NPT	1-3/8	3/8	1-1/8	 	
	00	B2769							
	0	B2770							
	1	B2771							
	2	B2772							
	3	B2773							
	4	B2774							
FTK 	3/0	B6555	5/16-24(3)* (5/32 or 4mm tube)	1/8NPT	1-3/4	3/8	15/16	 	
	00	B4128							
	0	B4129							
	1	B4130							
	2	B4131							
	3	B4132							
	4	B4133							
FTL 	3/0	B6556	5/16-24(4)* (5/32 or 4mm tube)	1/8NPT	1-3/4	3/8	1-1/8	 	
	00	B4368							
	0	B4369							
	1	B4370							
	2	B4371							
	3	B4372							
	4	B4373							
5	B4374								

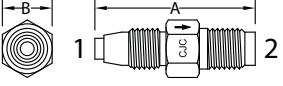

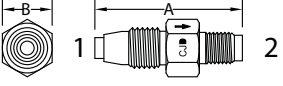

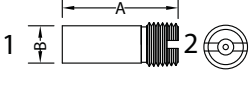

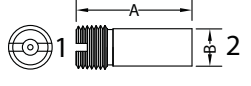
* See page 18-19 for tubing connections.



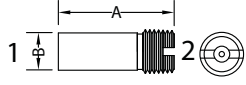

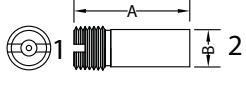

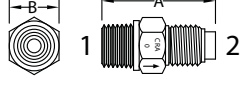

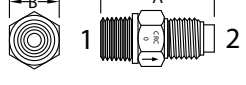



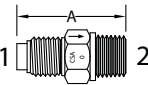

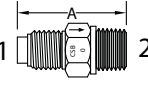
METER UNITS KITS		KIT INCLUDES													
KIT P.N.	INFO	B3264	B3265	B3254	B2496	B2495	B2497	B3784	A2835	A3080	B1095	B1371	B8272	A2435	5N25- 25
32567	4 PTS	1	0	0	4	1	1	3	2	2	6	7	13	6	1
32568	6 PTS	0	1	0	6	1	1	3	3	3	8	9	17	8	1
32569	8 PTS	0	0	1	8	1	1	3	4	4	10	11	21	10	2

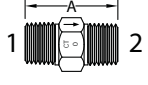

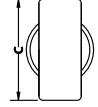
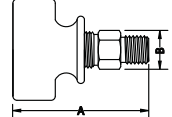

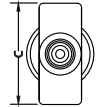
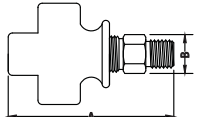

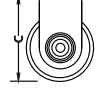
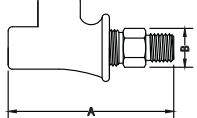

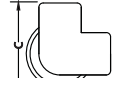
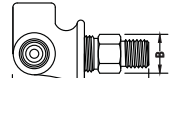
CONTROL UNITS		FLOW	BDI PART	THREADS (FLOW→)		DIMENSIONS			DRAWINGS
TYPE	RATE	#	Inlet(1)	Outlet(2)	A	B	C		
CB 	5/0	B8708	1/8NPT	1/8BSPT	53/64	7/16	-		
	4/0	B8709							
	3/0	B8710							
	00	B8711							
	0	B8712							
	1	B8713							
	2	B8374							
	3	B8714							
	4	B8715							
	5	B8716							
CF 	5/0	—	1/8NPT	1/8NPT	1-1/32	1/2	-		
	4/0	—							
	3/0	—							
	00	—							
	0	—							
	1	—							
	2	—							
	3	—							
	4	B6557							
	5	—							
CJB 	5/0	B7034	5/16-24	5/16-24* (5/32 or 4mm tube)	1-7/32	3/8	-		
	4/0	B7035							
	3/0	B7036							
	00	B7037							
	0	B7038							
	1	B7039							
	2	B6817							
	3	B6818							
	4	B6819							
	5	B6820							
CJC 	5/0	B7148	5/16-24	5/16-24* (3/32 tube)	1-7/32	3/8	-		
	4/0	B7149							
	3/0	B7150							
	00	B7151							
	0	B7152							
	1	B7153							
	2	B6930							
	3	B6931							
	4	B6932							
	5	B6933							
CJD 	5/0	B7164	5/16-24	1/4-28* (3/32 tube)	1-1/8	5/16	-		
	4/0	B7165							
	3/0	B7166							
	00	B7167							
	0	B7168							
	1	B7169							
	2	B7170							
	3	B7171							
	4	B7172							
	5	B7173							
CKA 	5/0	B7122	-	1/8NPT	29/32	9/32	-		
	4/0	B7123							
	3/0	B7124							
	00	B7125							
	0	B7126							
	1	B7127							
	2	B7128							
	3	B7129							
	4	B7130							
	5	B7131							
CKB 	5/0	B7133	1/8NPT	-	29/32	9/32	-		
	4/0	B7134							
	3/0	B7135							
	00	B7136							
	0	B7137							
	1	B7138							
	2	B7139							
	3	B6720							
	4	B7140							
	5	B7141							

* See page 18-19 for tubing connections.

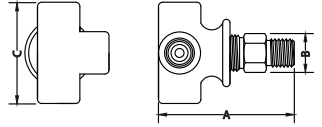
CONTROL UNITS		FLOW	BDI PART	THREADS (FLOW→)		DIMENSIONS			DRAWINGS
TYPE	RATE	#	Inlet(1)	Outlet(2)	A	B	C		
CKD 	5/0	26413-5/0	-	1/8BSPT	29/32	9/32	-		
	4/0	26413-4/0							
	3/0	26413-3/0							
	00	26413-00							
	0	26413-0							
	1	26413-1							
	2	26413-2							
	3	26413-3							
	4	26413-4							
5	26413-5								
CKE 	5/0	B9422	1/8BSPT	-	29/32	9/32			
	4/0	B9423							
	3/0	B9424							
	00	B9425							
	0	B9426							
	1	B9427							
	2	B9428							
	3	B9429							
	4	B9430							
5	B9431								
CRA 	5/0	B7142	1/8NPT	5/16-24* (5/32 or 4mm tube)	1	3/8			
	4/0	B7143							
	3/0	B7144							
	00	B7145							
	0	B7146							
	1	B7147							
	2	B7059							
	3	B7060							
	4	B7061							
5	B7062								
CRC 	5/0	B7154	1/8NPT	5/16-24* (3/32 tube)	1	3/8			
	4/0	B7155							
	3/0	B7156							
	00	B7157							
	0	B7158							
	1	B7159							
	2	B7160							
	3	B7161							
	4	B7162							
5	B7163								

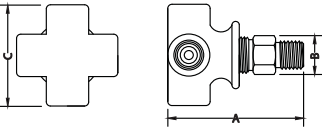
CONTROL UNITS		FLOW	BDI PART	THREADS (FLOW→)		DIMENSIONS			DRAWINGS
TYPE	RATE	#	Inlet(1)	Outlet(2)	A	B	C		
CSA 	5/0	B7022	5/16-24* (5/32-4mm tube)	1/8NPT	61/64	3/8	-	 	
	4/0	B7023							
	3/0	B7024							
	00	B7025							
	0	B7026							
	1	B7027							
	2	B6757							
	3	B6758							
	4	B6759							
	5	B6760							
CSB 	5/0	B8700	5/16-24* (5/32-4mm tube)	1/8BSPT	61/64	3/8	-	 	
	4/0	B8701							
	3/0	B8702							
	00	B8703							
	0	B8179							
	1	B8704							
	2	B8705							
	3	B8706							
	4	B8707							
	5	B8177							
CT 	5/0	B7028	1/8NPT	1/8NPT	53/64	3/8	-	 	
	4/0	B7029							
	3/0	B7030							
	00	B7031							
	0	B7032							
	1	B7033							
	2	B6764							
	3	B6765							
	4	B6766							
	5	B6767							
CTA 	5/0	B7174	5/16-24(2)* (5/32-4mm tube)	1/8NPT	1-3/8	3/8	1-1/8	 	
	4/0	B7175							
	3/0	B7176							
	00	B7177							
	0	B7178							
	1	B7179							
	2	B6775							
	3	B6776							
	4	B6777							
	5	B6778							
CTB 	5/0	B7192	5/16-24(3)* (5/32-4mm tube)	1/8NPT	1-3/4	3/8	1-1/8	 	
	4/0	B7193							
	3/0	B7194							
	00	B7195							
	0	B7196							
	1	B7197							
	2	B7198							
	3	B7199							
	4	B7200							
	5	B7201							
CTC 	5/0	B7186	5/16-24(2)* (5/32-4mm tube)	1/8NPT	1-3/4	3/8	151/6	 	
	4/0	B7187							
	3/0	B7188							
	00	B7189							
	0	B7190							
	1	B7191							
	2	B6779							
	3	B6780							
	4	B6781							
	5	B6782							
CTD 	5/0	B7180	5/16-24(2)* (5/32-4mm tube)	1/8NPT	1-3/8	3/8	15/16	 	
	4/0	B7181							
	3/0	B7182							
	00	B7183							
	0	B7184							
	1	B7185							
	2	B6783							
	3	B6784							
	4	B6785							
	5	B6786							

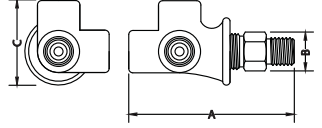
* See page 18-19 for tubing connections.

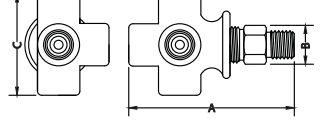
CONTROL UNITS		FLOW	BDI PART	THREADS (FLOW→)		DIMENSIONS			DRAWINGS
TYPE	RATE	#	Inlet(1)	Outlet(2)	A	B	C		
CTG 	5/0	B7212	5/16-24(3)* (5/32-4mm tube)	1/8NPT	1-3/8	3/8	1-1/8		
	4/0	B7213							
	3/0	B7214							
	00	B7215							
	0	B7216							
	1	B7217							
	2	B6787							
	3	B6788							
	4	B6789							
	5	B6790							
CTH 	5/0	B7218	5/16-24(4)* (5/32-4mm tube)	1/8NPT	1-3/8	3/8	1-1/8		
	4/0	B7219							
	3/0	B7220							
	00	B7221							
	0	B7222							
	1	B7223							
	2	B7224							
	3	B7225							
	4	B7226							
	5	B7227							
CTK 	5/0	B7202	5/16-24(3)* (5/32-4mm tube)	1/8NPT	1-3/4	3/8	15/16		
	4/0	B7203							
	3/0	B7204							
	00	B7205							
	0	B7206							
	1	B7207							
	2	B7208							
	3	B7209							
	4	B7210							
	5	B7211							
CTL 	5/0	B7228	5/16-24(4)* (5/32-4mm tube)	1/8NPT	1-3/4	3/8	1-1/8		
	4/0	B7229							
	3/0	B7230							
	00	B7231							
	0	B7232							
	1	B7233							
	2	B7234							
	3	B7235							
	4	B7236							
	5	B7237							

* See page 18-19 for tubing connections.

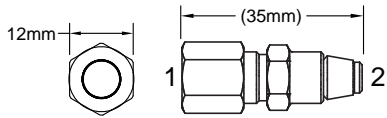
	BDI PART #	DESCRIPTION	CHECK VALVE	TYPE	TUBE/		DRAWING	
					TUBE (1)	THREADS (2)		
 *Stainless Steel	35360	OUTLET FITTING	Y	COMPRESSION	3/16"	M10X1		
	23397	OUTLET FITTING	Y	COMPRESSION	4mm	M10X1		
	23301	OUTLET FITTING	Y	COMPRESSION	6mm	M10X1		
	734490763*	OUTLET FITTING SS	Y	COMPRESSION	6mm	M10X1		
	AR5116	OUTLET FITTING	Y	HP PTC	1/4"	M10X1		
	35895	OUTLET FITTING	Y	HP PTC	4mm	M10X1		
	AR5195	OUTLET FITTING	Y	HP PTC	6mm	M10X1		
	29076	OUTLET FITTING	Y	-	1/8NPTF	M10X1		
	74161-1851	B PLUG	-	-	-	M10X1		
	23292	B CLAMP RING	-	-	-	-		
	74161-5741	C PLUG	-	-	-	M10X1		
	72712-1094	C WASHER	-	-	-	-		
741617621*	B PLUG SS	-	-	-	M10X1			
741617661*	C PLUG SS	-	-	-	M10X1			

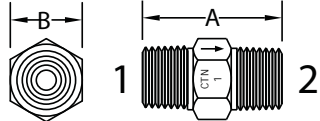
	BDI PART #	DESCRIPTION	THREADS (FLOW→)		DIMENSIONS		DRAWINGS
			Inlet(1)	Outlet(2)	A	B	
	21583-1	CTN-1	1/8NPT	1/8NPT	.83"	.375"	
	21583-2A	CTN-2					
	21583-5A	CTN-5					

	BDI PART #	THREADS	MAXIMUM PRESSURE		SWITCH RATING		ENCLOSURE	MONITORING CONNECTION
			PSI	BAR	MAX VOLTAGE	MAX CURRENT		
	55105	1/8NPT	10153	700	0-24 VDC	0.20 amp	IP67	M12 4-POLE
	55105-B	1/8BSPP						
	55105-SS	1/8NPT						

Operating Temp. Range:
-4° to 158° F
(-20° to 70° C)

Lubricant Range:
ISO VG32 OIL to NLGI #2 Grease

Material:
Aluminum/
Stainless (SS)

Vibrations:
20 g (10-20000 Hz)
(see page 73 for connection cables)

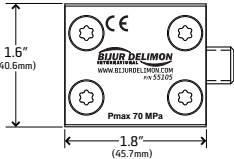
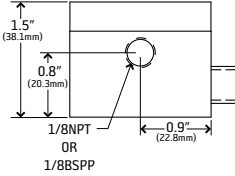
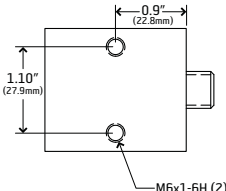
Refer to the following:
Datasheet: #35978



PIN #	Description	Wire Color
1	Common	Brown
4	Signal	Black

BDI PART #	VOLTAGE	Hz	ELEC. CONN.	CURRENT		PORT SIZE			TYPE	FLOW MAX	ENCL. NEMA	TEMP RANGE
				HOLDING	IN RUSH	INLET	OUTLET	EXHAUST				
Solenoid Valves Pneumatic												
20311-1	120VAC	50/60	1/2NPS	0.09 amps	0.12 amps	1/8NPTF	1/8NPTF	1/8NPTF	3/2	0.18Cv	1	0° to 140° F (-18° to 60° C)
20311-2	220VAC	50/60	1/2NPS	0.09 amps	0.12 amps	1/8NPTF	1/8NPTF	1/8NPTF	3/2	0.18Cv	1	
20311-3	120VAC	50/60	DIN 43650A	0.09 amps	0.12 amps	1/8NPTF	1/8NPTF	1/8NPTF	3/2	0.18Cv	1	
20311-4	240VAC	50/60	DIN 43650A	0.09 amps	0.12 amps	1/8NPTF	1/8NPTF	1/8NPTF	3/2	0.18Cv	1	
20311-5	24VDC	-	1/2NPS	6W		1/8NPTF	1/8NPTF	1/8NPTF	3/2	0.18Cv	1	
20311-6	12VDC	-	1/2NPS	6W		1/8NPTF	1/8NPTF	1/8NPTF	3/2	0.18Cv	1	
20311-7	24VDC	-	DIN 43650A	6W		1/8NPTF	1/8NPTF	1/8NPTF	3/2	0.18Cv	1	
20311-8	24VDC	-	DIN 43650A	6W		1/4NPTF	1/4NPTF	1/4NPTF	3/2	0.18Cv	1	
20311-9	120VAC	50/60	DIN 43650A	0.09amps	0.12 amps	1/4NPTF	1/4NPTF	1/4NPTF	3/2	0.18Cv	1	
20311-10	220VAC	50/60	DIN 43650A	0.09amps	0.12 amps	1/4NPTF	1/4NPTF	1/4NPTF	3/2	0.18Cv	1	
20311-11	24VDC	-	DIN 43650A	6W		1/4BSPP	1/4BSPP	1/4BSPP	3/2	0.18Cv	1	
20311-17	24VDC	-	DIN 43650A	6W		1/4NPTF	1/4NPTF	1/4NPTF	3/2	0.18Cv	1	
201594	120VAC	50/60	1/2NPTF	0.133 amps	0.333 amps	1/2NPTF	1/2NPTF	-	2/2	4.0Cv	4X	32° to 125° F (0° to 52° C)
U10602D3	240VAC	50/60	1/2NPTF	0.104 amps	0.292 amps	1/2NPTF	1/2NPTF	-	2/2	4.0Cv	4X	
201595	120VAC	50/60	1/2NPTF	0.133 amps	0.333 amps	3/4NPTF	3/4NPTF	-	2/2	6.5Cv	4X	
VAL10107B	120VAC	50/60	1/2NPTF	16 VA	40VA	1/2NPTF	1/2NPTF	-	2/2	4.0Cv	3/4/4X/7/9	
VAL13038A	120VAC	50/60	1/2NPT	25 VA	70 VA	1/2NPTF	1/2NPTF	-	2/2	4.0Cv	4X/7/9	
VAL13717A	120VAC	50/60	1/2NPTF	25 VA	50 VA	1/4NPTF	1/4NPTF	1/4NPTF	3/2	.12Cv	4X	32° to 356° F (0° to 180° C)
VAL13718A	120VAC	50/60	1/2NPTF	25VA	70VA	1/2NPTF	1/2NPTF	-	2/2	4.0Cv	1/2/3/3S/4 4X	
U10626A1	120VAC	50/60	1/2NPTF	0.09 amps	0.12 amps	1/4NPTF	1/4NPTF	3/8NPTF	3/2	1.4Cv	4	0° to 140° F (-18° to 60° C)
U10626C1	120VAC	50/60	1/2NPTF	0.09 amps	0.12 amps	3/8NPTF	3/8NPTF	3/8NPTF	3/2	1.6Cv	4	
U10626A2	240VAC	50/60	1/2NPTF	0.09 amps	0.12 amps	1/4NPTF	1/4NPTF	3/8NPTF	3/2	1.4Cv	4	
U10626C2	240VAC	50/60	1/2NPTF	0.09 amps	0.12 amps	3/8NPTF	3/8NPTF	3/8NPTF	3/2	1.6Cv	4	
U10626A5	24VDC	-	1/2NPTF	2.5W		1/4NPTF	1/4NPTF	3/8NPTF	3/2	1.4Cv	4	
VAL10662B	220/440VAC	50/60	3/4NPT			3/4NPT	3/4NPT	-	2/2	6.5Cv	4/7/9	

Solenoid Valves Pneumatic



Configuration: N.C.

Max Pressure: 150 psi (10.3 bar)

20311-17 : CSA Approved

VAL10107B/
VAL13038A/ :
Explosion proof and watertight.

VAL13718A/
VAL13717A:
includes a junction box with screw terminals & high temp coil.

VAL10662B:
250psi max

* DIN connector not included(see page 72)

DRAWINGS

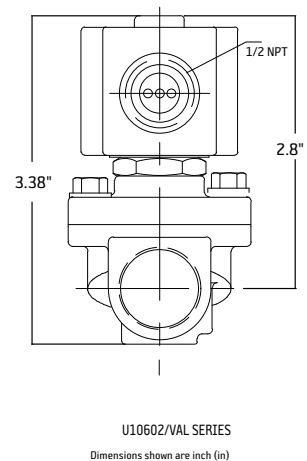
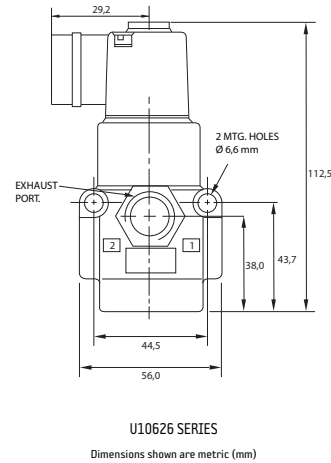
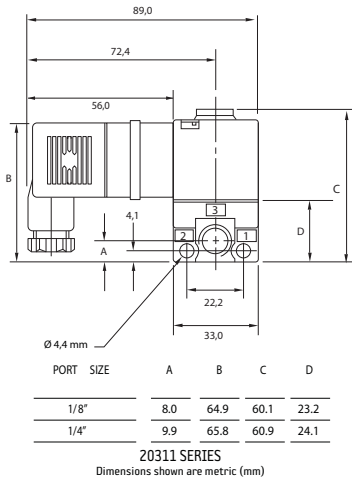

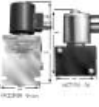
	BDI PART #	VOLTAGE	Hz	POWER	INRUSH CURRENT	PSI MAX	MEDIA	ELEC CONN	SEAL MATERIAL	REPLACEMENT COIL	
Solenoid Valves - Electric Shut Off/Zone Remote Mount  Temperature Range: Nitrile (Buna) -40° to 212° F (-40° to 100° C) Fluorocarbon (Viton) -15° to 400° F (-26° to 204° C) Function: N.C. (* N.O.) Port Size: 1/4 NPT Conduit: 1/2 NPSM Note: Manual Override on MCZ2504 models	MCZ2503B00HC24N	24VDC	-	20 W	0.85 amp	3000	GREASE	DIN 43650A	NITRILE	CIL13278B2	
	MCZ2503BV0HC24N	24VDC	-	20 W	0.85 amp	3000	GREASE	DIN 43650A	FLUORO-CARBON	CIL13278B2	
	MCZ2503B00BH24N	24VDC	-	20 W	0.85 amp	3000	GREASE	3-PIN AUTO	NITRILE	CIL13277A2	
	MCZ2503CV0DL24N*	24DC	-	20 W	0.85 amp	3000	GREASE	CONDUIT	NITRILE	CIL13276B2	
	MCZ2503CV0HC24N*	24DC	-	20 W	0.85 amp	3000	GREASE	DIN 43650A	NITRILE	CIL13278B2	
	MCZ2503B00DL11N	115VAC	50/60	20 W	0.17 amp	3000	GREASE	CONDUIT	NITRILE	CIL13276B3	
	MCZ2503B00BH11N	115VAC	50/60	20 W	0.17 amp	3000	GREASE	3-PIN AUTO	NITRILE	CIL13277A3	
	MCZ2504BV0DL11N	115VAC	50/60	20 W	0.17 amp	3000	GREASE	CONDUIT	FLUORO-CARBON	CIL13276B3	
	MCZ2504BV0HC11N	115VAC	50/60	20 W	0.17 amp	3000	GREASE	DIN 43650A	FLUORO-CARBON	CIL13278B3	
	MCZ2503BV0DL11N	115VAC	50/60	20 W	0.17 amp	3000	GREASE	CONDUIT	FLUORO-CARBON	CIL13276B3	
	MCZ2503B00BH22N	230VAC	50/60	20 W	0.09 amp	3000	GREASE	3-PIN AUTO	NITRILE	CIL13277A4	

DRAWINGS

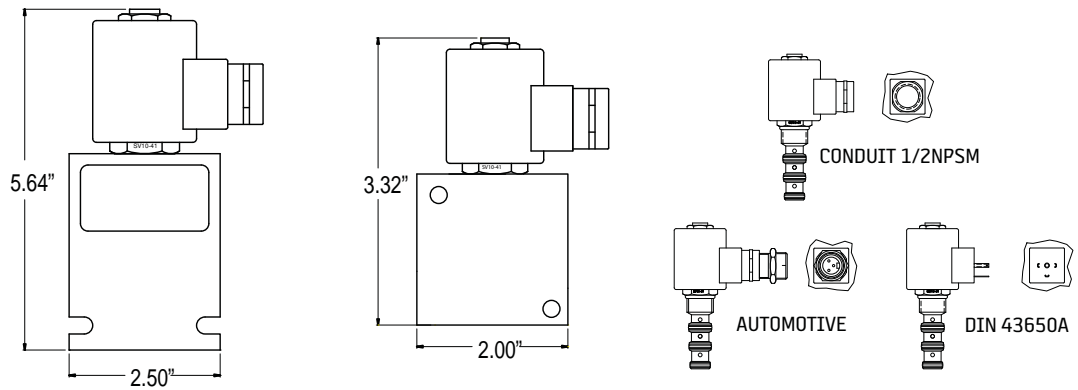

Dimensions shown are inch (in)

	BDI PART #	VOLTAGE	Hz	HOLDING CURRENT	HOLDING POWER	VOLTAGE RANGE	ELECTRICAL CONNECTION	PORT SIZE
Solenoid Valves - Electric Shut Off/Zone	39909	115VAC	50/60	0.49 amp	34 W	80-130V	1/2NPTF	3/8NPTF
	37214	230VAC	50/60	0.24 amp	33 W	180-250V	1/2NPTF	3/8NPTF
	37196	24VDC	-	1.5 amp	36 W	21.6-26.4V	1/2NPTF	3/8NPTF
DRAWINGS								
<p>Operating Temp. Range: 41° to 140° F (5° to 60° C)</p> <p>Function: N.C.</p> <p>Max Pressure: 5000 psi (345 bar)</p> <p>Max Flow: 12 gpm</p> <p>Media: 80SUS Oil up to NLGI #2 Grease</p>								

	BDI PART #	VOLTAGE	Hz	TIMER RANGE	ELEC CONN
Solenoid On-Off Timer -DIN connection*	29927	24-240V AC/DC	50/60(AC)	ON 2-40 Sec/OFF 0.5-45 Min	DIN 43650 FORM A
	71740	24-240V AC/DC	50/60(AC)	ON 0.5-99 Sec/OFF 0.5-99 Min	DIN 43650 FORM A
DRAWINGS					
<p>Operating Temp. Range: 14° to 122° F (-10° to 50° C)</p> <p>ENCLOSURE: IP65 *Fits 20311 solenoids (see page 39)</p>					

	BDI PART #	VOLTAGE	Hz	TIMER RANGE	ELEC CONN	CONTACT FORM	CURRENT RATING
On-Off Timer	35074	24VDC - 24-240VAC	50/60 (VAC)	0.1 Seconds - 100 Hours	SCREW TERM	SPDT	10A
DRAWINGS							
<p>Repeat Cycle</p> <p>MOUNTING: DIN RAIL</p> <p>STANDARDS: UL listed cUL listed CSA recognized CE Approved</p>							

	BDI PART #	VOLTAGE	Hz	FAULT RELAY CONTACTS	ELECTRICAL CONNECTION	REF DATA SHEET	ENCLOSURE RATING	FEATURES / MODES
	22361-E2	110VAC	50/60	30W	CABLE GLAND	46912	IP55	TIMER / INJ / PROG / PULSE
	22361-E1	220VAC	50/60	30W	CABLE GLAND		IP55	TIMER / INJ / PROG / PULSE
	33346E	12/24VDC	-	24VDC,1A	CABLE GLAND	46911	IP67	TIMER / INJ / PROG / PULSE
	33346ME	12/24VDC	-	24VDC,1A	EXT TERM STRIP		IP47	TIMER / INJ / PROG / PULSE
	SC400	85-265VAC	50/60	5A	INT TERM STRIP	35980	IP56	INJ/PROG/DUALINE/CONT
	SC400CSA							CSA APPROVED

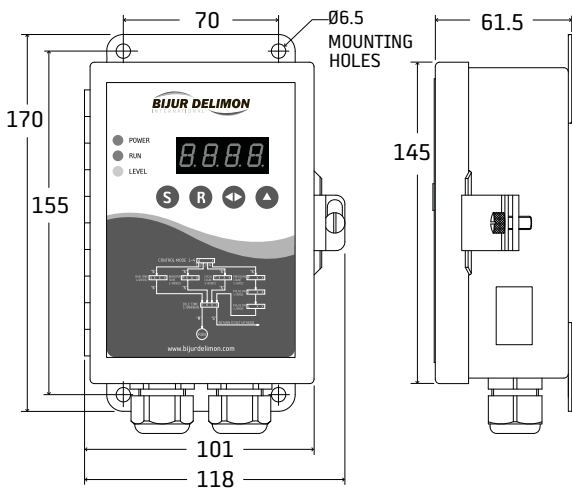

Measurements shown in millimeters.

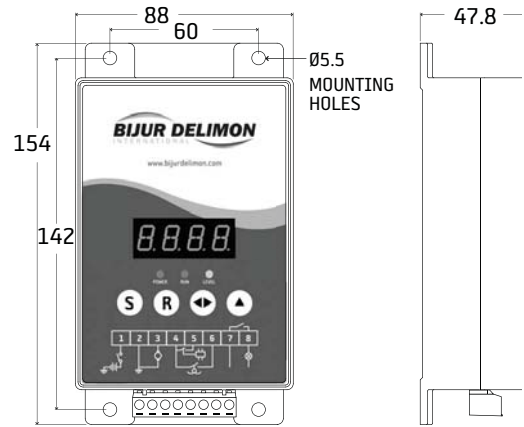

Measurements shown in millimeters.

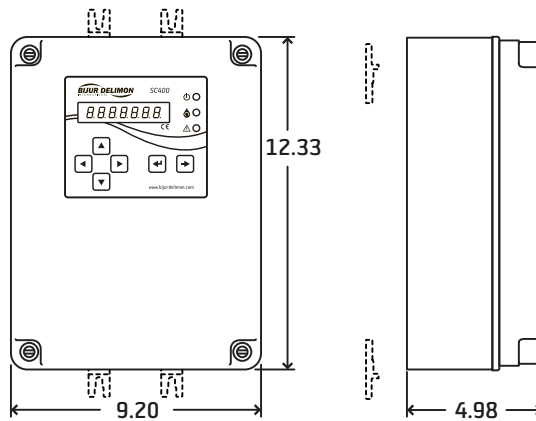

BDI PART #	VOLTAGE	Hz	CONTACT RATINGS	CIRCUITRY	CONNECTION	ENCLOSURE	ACTION	NOTES
Switches								
U625	125-460VAC	50/60	15A	SPDT	1/2NPTF	NEMA 7/9	ROLLER LEVER	XP, UL
U10623	125-480VAC	50/60	15A	SPDT	1/2NPTF	NEMA 1	PLUNGER	MC13974B MC13975B FT15801C8 LC10243/LC11036
	125VDC	-						
201132	125-480VAC	50/60				NEMA 4		LB11398 & 201134
30544	125-250VAC	50/60	10A	SPDT	TERM STRIP	NEMA 1	PLUNGER	MULTIPOINT I 1000
	480VAC	50/60	3A					
	8-14VDC	-	10A					
	30VDC	-	6A					
	125VDC	-	0.50A					
250VDC	-	0.25A						
MC13975B	125-480VAC 125VDC	50/60	15A	SPDT	AUTOMOTIVE 3-PIN	NEMA 1	PLUNGER	M2500
MC13974B								M2500
FT15801C8								3000
LC10243								120LB DRUM LLS
LC11036								400LB DRUM LLS
LB11398								3000
201134								DM61300C/DM62300C ONLY
17324	600VAC	50/60	15A	SPDT	1/2NPTF	NEMA 4	PLUNGER	M2500G
	250VDC	-	0.5A					
33583	BRACKET FOR 17324							
MCSA2503	250VAC	50/60	5A	SPDT	AUTOMOTIVE 3-PIN	-	MAGNET	M2500G M2500
	28VDC	-	5A					
66925-1311	10-30VDC	-	200mA	N.O. PNP	M12 (4-POLE)	IP65	PROX	PVB PVBM M2500G
66925S003			100mA	N.O. NPN				

DRAWINGS

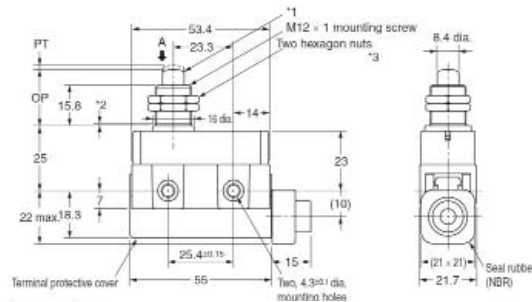

U SERIES

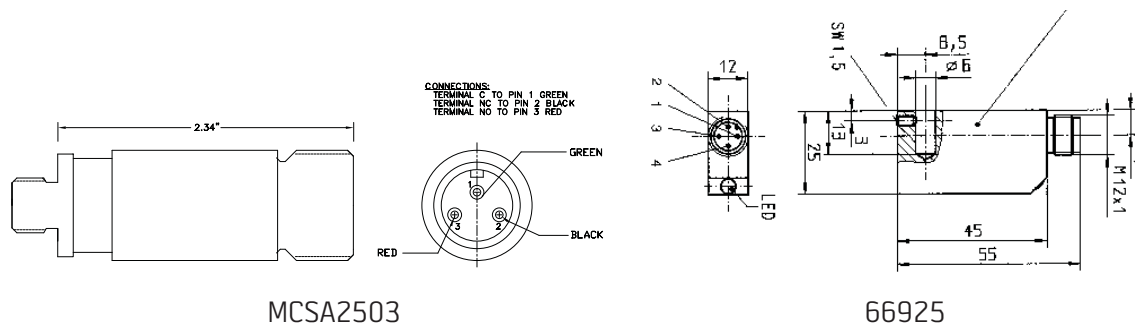

Junction Headers



Used with Meter & Control Units (FT/CT)

Die Cast Zinc Alloy

Inlet is for 5/32 (4mm) tube connection. Accepts compression sleeve B1061 or B8272 and compression bushing B1371 or B3783.

BDI PART #	TYPE	5/16-24 INLETS	TUBE SIZE	1/8NPTF OUTLETS	DRAWING ITEM #
B1503	TA	2	5/32 (4MM)	1	1
B1538	TC	2	5/32 (4MM)	1	2
B1539	TD	2	5/32 (4MM)	1	3
B3150	TG	3	5/32 (4MM)	1	4
B1504	TB	3	5/32 (4MM)	1	5
B4047	TK	3	5/32 (4MM)	1	6
B2810	TH	4	5/32 (4MM)	1	7
B4367	TL	4	5/32 (4MM)	1	8

DRAWINGS

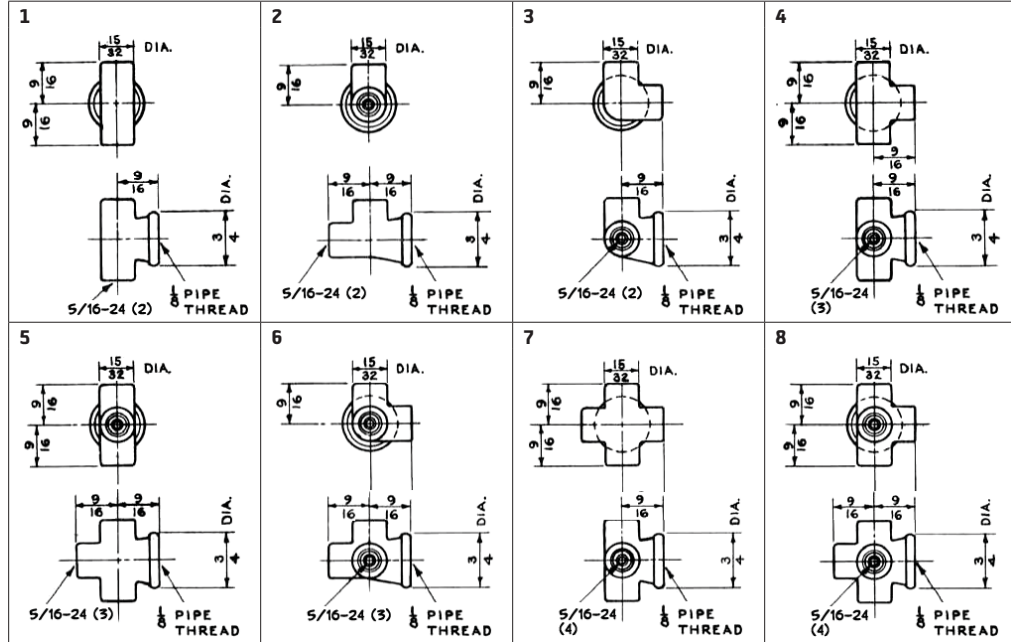

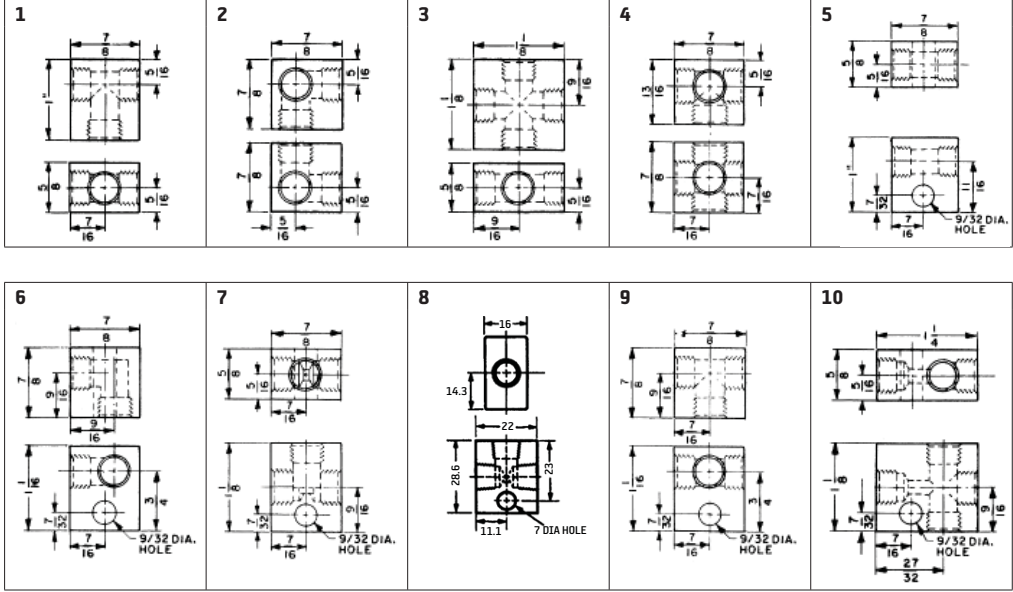

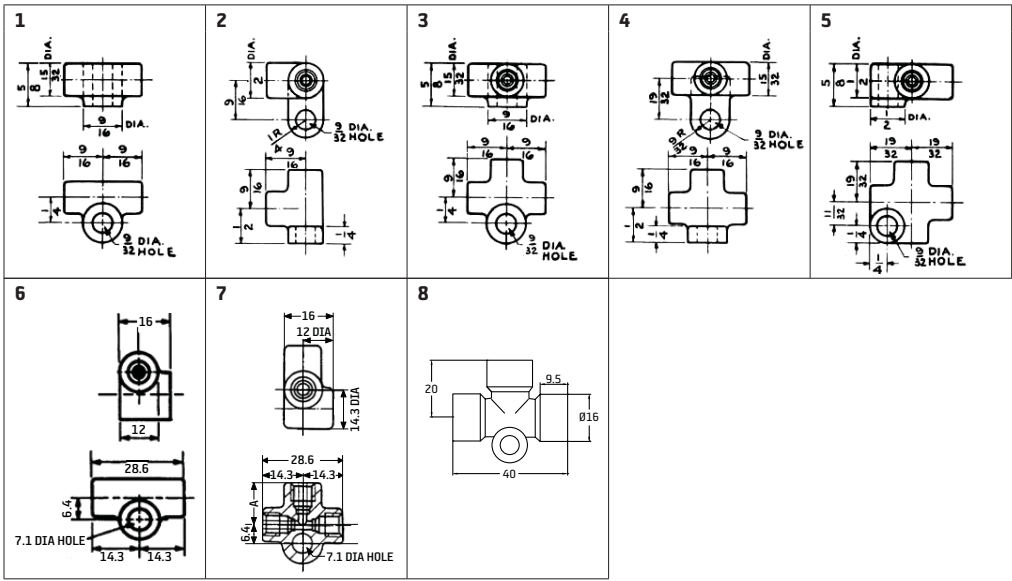
	BDI PART #	TYPE	THREADS	MOUNTING HOLE		DRAWING ITEM #
				HAS MOUNTING HOLE	SIZE	
Junction Blocks 	B7682	3 WAY	1/8 NPTF	NO	-	1
	B7683	3 WAY	1/8 NPTF	NO	-	2
	B7684	4 WAY	1/8 NPTF	NO	-	3
	B7690	2 WAY	1/8 NPTF	YES	9/32"	5
	B7691	2 WAY	1/8 NPTF	YES	9/32"	6
	B7692	3 WAY	1/8 NPTF	YES	9/32"	7
	17186	3 WAY	1/8 BSPT	YES	7mm	8
	B7693	3 WAY	1/8 NPTF	YES	9/32"	9
	B7694	4 WAY	1/8 NPTF	YES	9/32"	10
	DRAWINGS					
1/8" NPTF & 1/8" BSPT Aluminum Alloy						

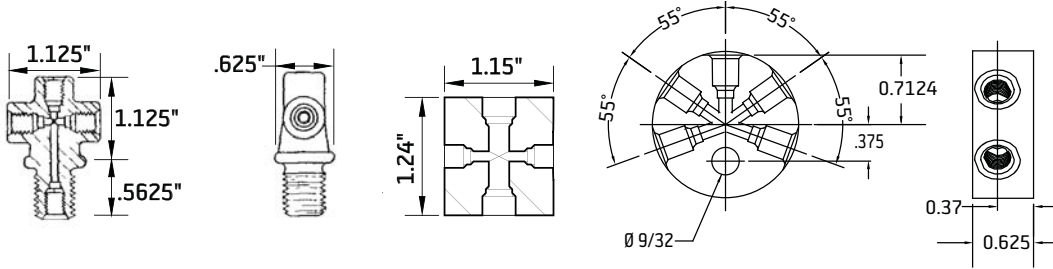
	BDI PART #	TYPE	THREADS	TUBE SIZE	MOUNTING HOLE SIZE	DRAWING ITEM #
Junctions  5/16-24, M8X1 & M10X1 Alum Zinc Die Cast Alloy 9/32" Mounting Hole	B3288	2 WAY	5/16-24	5/32 (4MM)	9/32"	1
	B5149	2 WAY	5/16-24	5/32 (4MM)	9/32"	2
	B3065	3 WAY	5/16-24	5/32 (4MM)	9/32"	3
	B1092	3 WAY	5/16-24	5/32 (4MM)	9/32"	4
	B4231	4 WAY	5/16-24	5/32 (4MM)	9/32"	5
	31002	2 WAY	M10X1	6MM	9/32"	1
	31003	3 WAY	M10X1	6MM	9/32"	3
	31004	4 WAY	M10X1	6MM	9/32"	5
	22609	2 WAY	M8X1	4MM	7.1mm	6
	22564	3 WAY	M8X1	4MM	7.1mm	7
	73462-3443	3 WAY	M10X1	6MM	6.5mm	8
DRAWINGS						
						

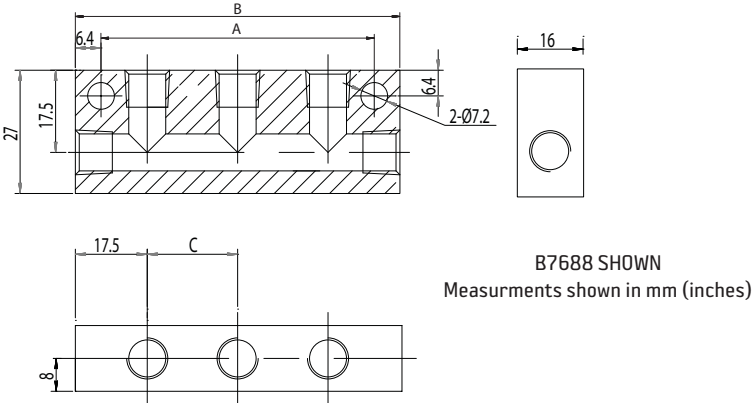
	BDI PART #	TYPE	OUTLETS	THREADS		TUBE SIZE	INCLUDES		NOTES	
				INLET	OUTLETS		MOUNTING HOLE	SIZE		
Junctions Specials  Alum Zinc Die Cast Alloy (B1096 Aluminum)	B9849	4 WAY	3	1/2-20 (1)	5/16-24 (3)	5/32 (4MM)	NO	USED ON OLD STYLE L5H D3508		
	22171	4 WAY	3	M10X1 (1)	1/8NPTF (1) 5/16-24 (2)	5/32 (4MM)	NO	USED ON L5H D3508C		
	B1096	5 WAY	4	5/16-24 (1)	5/16-24 (4)	5/32 (4MM)	YES	FLAT MOUNTED		
DRAWINGS										
										
			B9849				22171			
						B1096				

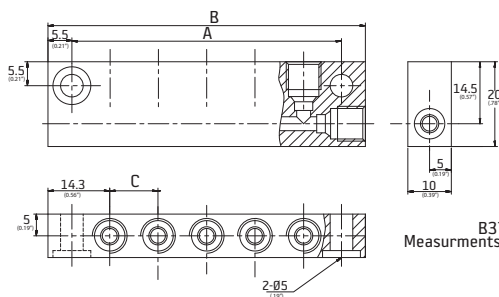
	BDI PART #	TYPE	OUTLETS	THREADS		MOUNTING HOLE		DRAWING ITEM #
				INLET	OUTLET	HAS MOUNTING HOLE	SIZE	
Junctions Bars  1/8" NPTF Aluminum Alloy Single sided 2 Mounting Holes	B7687	4 WAY	2	1/8NPTF (2)	1/8NPTF (2)	1.75"(44.5mm)	2.25"(57.3mm)	.877"(22.3mm)
	B7688	5 WAY	3	1/8NPTF (2)	1/8NPTF (3)	2.625"(66.7mm)	3.125"(79.5mm)	.877"(22.3mm)
	B7689	6 WAY	4	1/8NPTF (2)	1/8NPTF (4)	3.5"(89mm)	4.0"(102mm)	.877"(22.3mm)
	B8897	7 WAY	5	1/8NPTF (2)	1/8NPTF (5)	4.375"(111.2mm)	4.875"(124.2mm)	.877"(22.3mm)
	B8898	8 WAY	6	1/8NPTF (2)	1/8NPTF (6)	5.25"(133.4mm)	5.75"(146.5mm)	.877"(22.3mm)
	B8899	10 WAY	8	1/8NPTF (2)	1/8NPTF (8)	7.0"(177.8mm)	7.5"(191.1mm)	.877"(22.3mm)
	DRAWINGS							
								

	BDI PART #	TYPE	OUTLETS	THREADS		MOUNTING HOLE		DRAWING ITEM #
				INLET	OUTLET	HAS MOUNTING HOLE	SIZE	
Junctions Bars  5/16-24 Aluminum Alloy Single sided 2 Mounting Holes FJD & CJD	B3764	4 WAY	2	5/16-24 (2)	5/16-24 (2)	1.125"(28.6mm)	1.562"(39.7mm)	.437"(11.1mm)
	B3765	5 WAY	3	5/16-24 (2)	5/16-24 (3)	1.5625"(40mm)	2.0"(51mm)	.437"(11.1mm)
	B3766	6 WAY	4	5/16-24 (2)	5/16-24 (4)	2.0"(50.8mm)	2.4375"(62mm)	.437"(11.1mm)
	B3767	7 WAY	5	5/16-24 (2)	5/16-24 (5)	2.4375"(62mm)	2.875"(73mm)	.437"(11.1mm)
	B3768	8 WAY	6	5/16-24 (2)	5/16-24 (6)	2.875"(73mm)	3.3125"(84mm)	.437"(11.1mm)
	B3769	9 WAY	7	5/16-24 (2)	5/16-24 (7)	3.3125"(84.2mm)	3.75"(95.2mm)	.437"(11.1mm)
	B3770	10 WAY	8	5/16-24 (2)	5/16-24 (8)	4.1875"(95.3mm)	4.1875"(106.3mm)	.437"(11.1mm)
	B3771	11 WAY	9	5/16-24 (2)	5/16-24 (9)	4.1875"(106.4mm)	4.625"(117.4mm)	.437"(11.1mm)
	B3772	12 WAY	10	5/16-24 (2)	5/16-24 (10)	4.625"(117.5mm)	5.0625"(128.5mm)	.437"(11.1mm)
	DRAWINGS							
 <p style="text-align: right;">B3767 SHOWN Measurements shown in mm (inches)</p>								

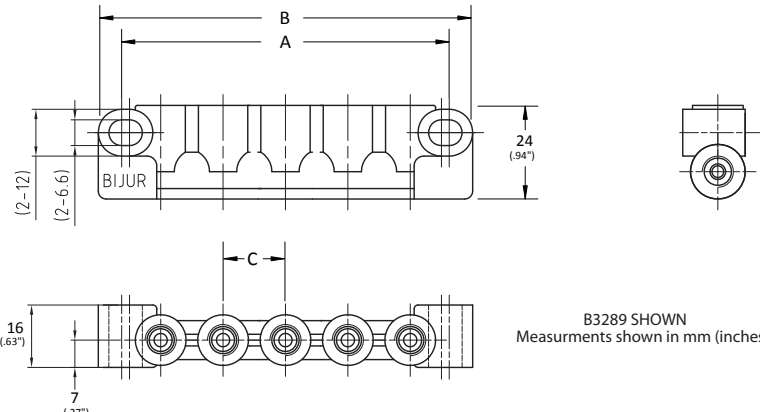
	BDI PART #	TYPE	OUTLETS	DIMENSIONS					
				INLET	OUTLETS	A	B	C	
Junctions Bars  5/16-24 Alum Zinc Die Cast Single sided 2 Mounting Holes FJB, FJC, CJB, CJC QJB, ZJBE	B3262	4 WAY	2	5/16-24 (2)	5/16-24 (2)	36mm	48mm	16mm	
	B3263	5 WAY	3	5/16-24 (2)	5/16-24 (3)	52mm	64mm	16mm	
	B3264	6 WAY	4	5/16-24 (2)	5/16-24 (4)	68mm	80mm	16mm	
	B3289	7 WAY	5	5/16-24 (2)	5/16-24 (5)	84mm	96mm	16mm	
	B3265	8 WAY	6	5/16-24 (2)	5/16-24 (6)	100mm	112mm	16mm	
	B4508	9 WAY	7	5/16-24 (2)	5/16-24 (7)	116mm	128mm	16mm	
	B3704	10 WAY	8	5/16-24 (2)	5/16-24 (8)	132mm	144mm	16mm	
	B3471	12 WAY	10	5/16-24 (2)	5/16-24 (10)	164mm	176mm	16mm	
	DRAWINGS								
	 <p style="text-align: right;">B3289 SHOWN Measurements shown in mm (inches)</p>								

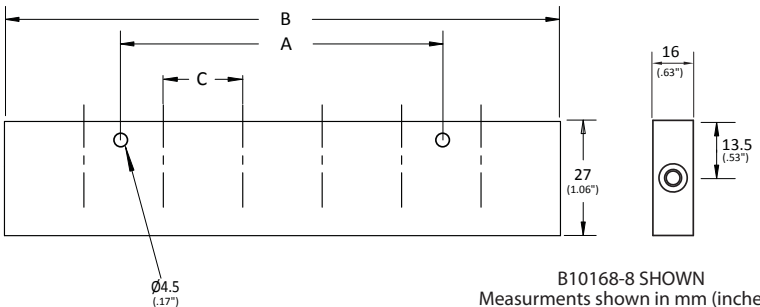
	BDI PART #					DIMENSIONS		
	TYPE	OUTLETS	INLET	OUTLETS	A	B	C	
Junctions Bars  M10X1 Aluminum Alloy Single sided 2 Mounting Holes ZEE, ZEG, ZMBE, ZMBM B10164 has 1-mtg hole	B10164	4 WAY	2	M10X1 (2)	M10X1 (2)	-	57mm	18mm
	B10168-6	6 WAY	4	M10X1 (2)	M10X1 (4)	36mm	93mm	18mm
	B10168-8	8 WAY	6	M10X1 (2)	M10X1 (6)	72mm	129mm	18mm
DRAWINGS								
 <p style="text-align: right;">B10168-8 SHOWN Measurements shown in mm (inches)</p>								

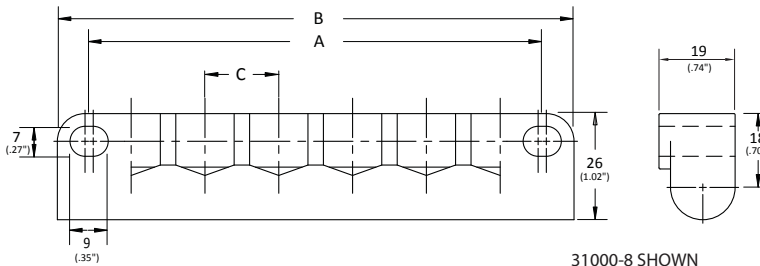
	BDI PART #					DIMENSIONS		
	TYPE	OUTLETS	INLET	OUTLETS	A	B	C	
Junctions Bars  M10X1 Alum Zinc Die Cast Single sided 2 Mounting Holes ZEE, ZEG, ZMBE, ZMBM	31000-5	5 WAY	3	M10X1 (2)	M10X1 (3)	54mm	69mm	16mm
	31000-6	6 WAY	4	M10X1 (2)	M10X1 (4)	70mm	85mm	16mm
	31000-8	8 WAY	6	M10X1 (2)	M10X1 (6)	102mm	117mm	16mm
	31000-9	9 WAY	7	M10X1 (2)	M10X1 (7)	118mm	133mm	16mm
	31000-10	10 WAY	8	M10X1 (2)	M10X1 (8)	134mm	149mm	16mm
	DRAWINGS							
 <p style="text-align: right;">31000-8 SHOWN Measurements shown in mm (inches)</p>								

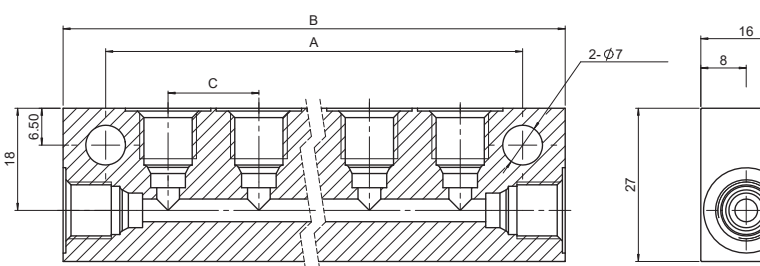
	BDI PART #					DIMENSIONS		
	TYPE	OUTLETS	INLET	OUTLETS	A	B	C	
Junctions Bars  M10X1 Alum Zinc Die Cast Single sided 2 Mounting Holes ZEE, ZEG, ZMBE, ZMBM	90273-4	4 WAY	2	M10X1 (2)	M10X1 (2)	38mm	53mm	16mm
	90273-5	5 WAY	3	M10X1 (2)	M10X1 (3)	54mm	69mm	16mm
	31000-6	6 WAY	4	M10X1 (2)	M10X1 (4)	70mm	85mm	16mm
	90273-7	7 WAY	5	M10X1 (2)	M10X1 (5)	86mm	101mm	16mm
	90273-8	8 WAY	6	M10X1 (2)	M10X1 (6)	102mm	117mm	16mm
	90273-9	9 WAY	7	M10X1 (2)	M10X1 (7)	118mm	133mm	16mm
	90273-10	10 WAY	8	M10X1 (2)	M10X1 (8)	134mm	149mm	16mm
	DRAWINGS							
								

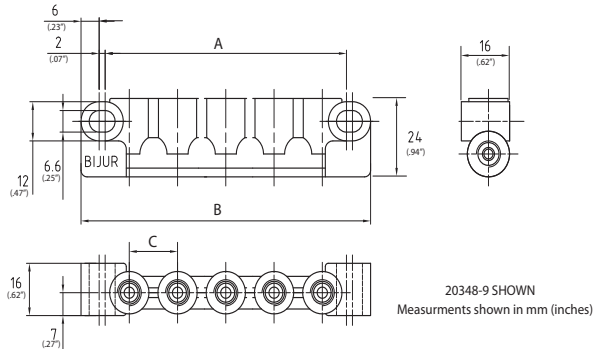
	BDI PART #	TYPE	OUTLETS	INLET		OUTLETS		DIMENSIONS		
								A	B	C
 Junctions Bars M8X1 Alum Zinc Die Cast Single sided 2 Mounting Holes AJB, QJM, ZJBM	20348-4	4 WAY	2	M8X1 (2)	M8X1 (2)	36mm	48mm	16mm		
	20348-5	5 WAY	3	M8X1 (2)	M8X1 (3)	52mm	64mm	16mm		
	20348-6	6 WAY	4	M8X1 (2)	M8X1 (4)	68mm	80mm	16mm		
	20348-7	7 WAY	5	M8X1 (2)	M8X1 (5)	84mm	96mm	16mm		
	20348-8	8 WAY	6	M8X1 (2)	M8X1 (6)	100mm	112mm	16mm		
	20348-9	9 WAY	7	M8X1 (2)	M8X1 (7)	116mm	128mm	16mm		
	20348-10	10 WAY	8	M8X1 (2)	M8X1 (8)	132mm	144mm	16mm		
	20348-12	12 WAY	10	M8X1 (2)	M8X1 (10)	164mm	176mm	16mm		
	DRAWINGS									
										

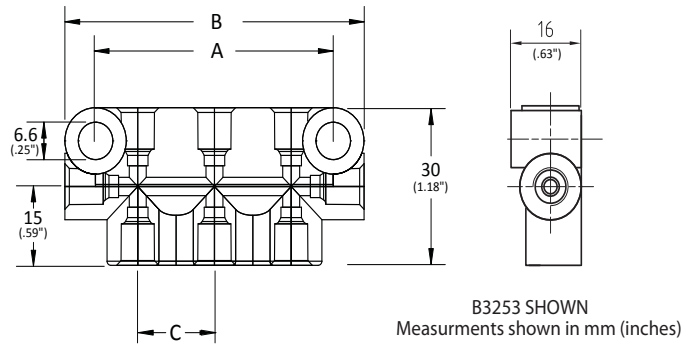
	BDI PART #	TYPE	OUTLETS	INLET		OUTLETS		DIMENSIONS		
								A	B	C
 Junctions Bars 5/16-24 Alum Zinc Die Cast Double sided 2 Mounting Holes FJB, FJC, CJB, CJC QJB, ZJBE	B3109	6 WAY	4	5/16-24 (2)	5/16-24 (4)	36mm	48mm	16mm		
	B3253	8 WAY	6	5/16-24 (2)	5/16-24 (6)	50mm	62mm	16mm		
	B3254	10 WAY	8	5/16-24 (2)	5/16-24 (8)	66mm	78mm	16mm		
	B3249	12 WAY	10	5/16-24 (2)	5/16-24 (10)	81mm	93.7mm	16mm		
	B4020	14 WAY	12	5/16-24 (2)	5/16-24 (12)	96.8mm	108mm	16mm		
	B4025	16 WAY	14	5/16-24 (2)	5/16-24 (14)	112.7mm	125.4mm	16mm		
	DRAWINGS									
										

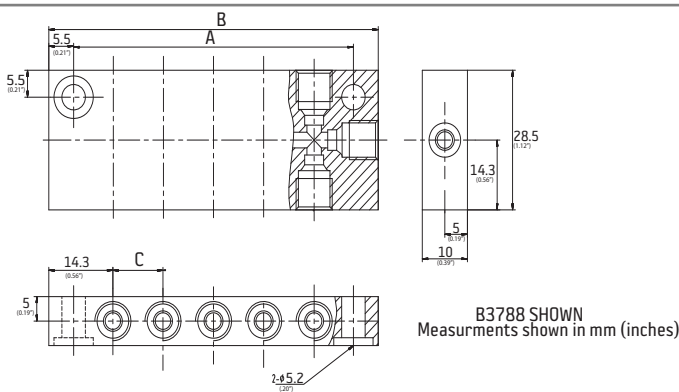
	BDI PART #	TYPE	OUTLETS	INLET		OUTLETS		DIMENSIONS		
								A	B	C
Junctions Bars  5/16-24 Aluminum Alloy Double sided 2 Mounting Holes FJD, CJD	B3785	6 WAY	4	5/16-24 (2)	5/16-24 (4)	28.6mm(1.12")	39.6mm (1.56")	11.1mm (.43")		
	B3786	8 WAY	6	5/16-24 (2)	5/16-24 (6)	40mm(1.5625")	51mm(2.0")	11.1mm (.43")		
	B3787	10 WAY	8	5/16-24 (2)	5/16-24 (8)	50.8mm(2.0")	62mm(2.43")	11.1mm (.43")		
	B3788	12 WAY	10	5/16-24 (2)	5/16-24 (10)	61.9mm (2.43")	73mm (2.87")	11.1mm (.43")		
	B3789	14 WAY	12	5/16-24 (2)	5/16-24 (12)	73mm(2.87")	84mm(3.12")	11.1mm (.43")		
DRAWINGS										
										

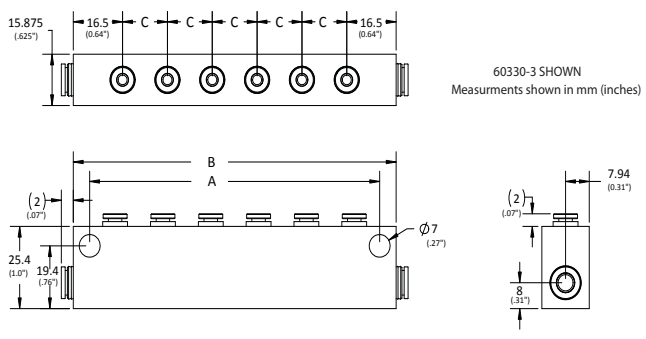
	BDI PART #	TYPE	OUTLETS	INLET		OUTLETS		DIMENSIONS		
								A	B	C
Junctions Bars  Quick Connect Aluminum Bar Single sided 2 Mounting Holes 4mm & 6mm	60330-2	2 WAY	2	6mm (2)	4mm (2)	37mm	49mm	15mm		
	60330-3	3 WAY	3	6mm (2)	4mm (3)	52mm	63mm	15mm		
	60330-4	4 WAY	4	6mm (2)	4mm (4)	67mm	78mm	15mm		
	60330-5	5 WAY	5	6mm (2)	4mm (5)	82mm	93mm	15mm		
	60330-6	6 WAY	6	6mm (2)	4mm (6)	97mm	108mm	15mm		
DRAWINGS										
										

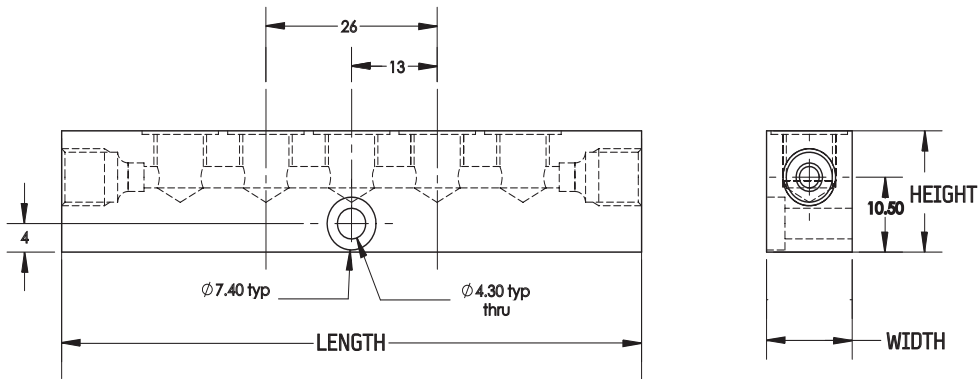
	BDI PART #	TYPE	OUTLETS	THREADS		MOUNTING HOLES			DIMENSIONS		
				INLETS	OUTLETS	#	SPACING	Ø DIA.	LENGTH	HEIGHT	WIDTH
 <p>Aluminum Alloy Single sided</p>	34547	3 WAY	1	M12X1 (2)	M14X1.5 (1)	1	-	4.3mm	40mm	35mm	25mm
	ZEM32M14	3 WAY	1	M8X1 (2)	M8X1 (1)	1	-		39mm	17mm	13mm
	ZEM32M16	3 WAY	1	M10X1 (2)	M8X1 (1)	1	-		39mm	17mm	13mm
	ZEM32M18	3 WAY	1	M14X1.5 (2)	M8X1 (1)	1	-		48mm	20mm	18mm
	ZEM32M24	4 WAY	2	M8X1 (2)	M8X1 (2)	1	-		49mm	17mm	13mm
	ZEM32M26	4 WAY	2	M10X1 (2)	M8X1 (2)	1	-		52mm	17mm	13mm
	ZEM32M28	4 WAY	2	M14X1.5 (2)	M8X1 (2)	1	-		61mm	20mm	18mm
	ZEM32M34	5 WAY	3	M8X1 (2)	M8X1 (3)	1	-		62mm	17mm	13mm
	ZEM32M36	5 WAY	3	M10X1 (2)	M8X1 (3)	1	-		65mm	17mm	13mm
	ZEM32M38	5 WAY	3	M14X1.5 (2)	M8X1 (3)	1	-		74mm	20mm	18mm
	ZEM32M46	6 WAY	4	M10X1 (2)	M8X1 (4)	1	-		78mm	17mm	13mm
	ZEM32M54	7 WAY	5	M8X1 (2)	M8X1 (5)	1	-		88mm	17mm	13mm
	ZEM32M56	7 WAY	5	M10X1 (2)	M8X1 (5)	1	-		91mm	17mm	13mm
	ZEM32M58	7 WAY	5	M14X1.5 (2)	M8X1 (5)	1	-		100mm	20mm	18mm
	ZEM32M66	8 WAY	6	M10X1 (2)	M8X1 (6)	2	39mm		104mm	17mm	13mm
	ZEM32M76	9 WAY	7	M10X1 (2)	M8X1 (7)	2	39mm		117mm	17mm	13mm
	ZEM32M86	10 WAY	8	M10X1 (2)	M8X1 (8)	2	52mm		130mm	17mm	13mm
	ZEM32M96	11 WAY	9	M10X1 (2)	M8X1 (9)	2	52mm		143mm	17mm	13mm
	ZEM32M106	12 WAY	10	M10X1 (2)	M8X1 (10)	2	78mm		156mm	17mm	13mm
	DRAWINGS										
											

	BDI PART #	TYPE	OUTLETS	THREADS		MOUNTING HOLES			DIMENSIONS		
				INLETS	OUTLETS	#	SPACING	Ø DIA.	LENGTH	HEIGHT	WIDTH
<p>Aluminum Alloy Single sided</p>	ZEM33M26	4 WAY	2	M10X1 (2)	M10X1 (2)	1	-	4.3mm	58mm	20mm	18mm
	ZEM33M86	10 WAY	8	M10X1 (2)	M10X1 (8)	2	102mm		160mm	20mm	18mm
	ZEM33M126	14 WAY	12	M10X1 (2)	M10X1 (10)	2	170mm		228mm	20mm	18mm
DRAWINGS											

	BDI PART #	TYPE	OUTLETS	THREADS		MOUNTING HOLES			DIMENSIONS		
				INLETS	OUTLETS	#	SPACING	Ø DIA.	LENGTH	HEIGHT	WIDTH
<p>Aluminum Alloy Double sided</p>	ZEM32M54D	7 WAY	5	M8X1 (2)	M8X1 (5)	1	-	4.3mm	62mm	17mm	13mm
	ZEM32M56D	7 WAY	5	M10X1 (2)	M8X1 (5)	1	-		65mm	17mm	13mm
	ZEM32M58D	7 WAY	5	M14X1.5 (2)	M8X1 (5)	1	-		74mm	20mm	18mm
DRAWINGS											

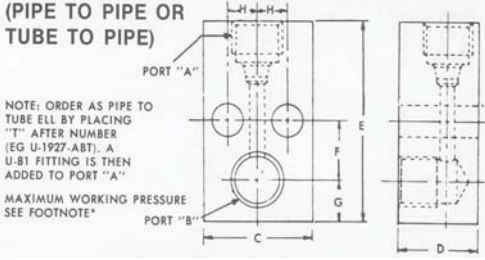
	BDI PART #	PORT A			PORT B			DIMENSIONS					MOUNTING HOLES	
		PIPE SIZE	TUBE SIZE	U-81 NO.	PIPE SIZE	C	D	E	F	G	H	#	Ø DIA.	
 <p>Anchor Ell</p> <p>Includes mounting screws</p> <p>Max 6000psi for pipe</p> <p>"T" Type includes U-81 fittings</p>	U1927A	1/8	3/16	U81AA1	1/8	7/8	5/8	1-1/2	7/16	5/16	15/64	2	15/64	
	U1927AB	1/4	1/4	U81B2	1/8	1-1/4	7/8	1-7/8	1/2	3/8	11/32	2	9/32	
	U1927B	1/4	1/4	U81B2	1/4	1-1/4	7/8	1-7/8	1/2	3/8	11/32	2	9/32	
	U1927C	3/8	3/8	U81D3	3/8	1-1/2	1-1/4	2-1/8	1/2	1/2	1/2	2	9/32	
	U1927AT	1/8	3/16	U81AA1	1/8	7/8	5/8	1-1/2	7/16	5/16	15/64	2	15/64	
	U1927BT	1/4	1/4	U81B2	1/4	1-1/4	7/8	1-7/8	1/2	3/8	11/32	2	9/32	
	U1927CT	3/8	3/8	U81D3	3/8	1-1/2	1-1/4	2-1/8	1/2	1/2	1/2	2	9/32	
DRAWINGS														
 <p>(PIPE TO PIPE OR TUBE TO PIPE)</p> <p>NOTE: ORDER AS PIPE TO TUBE ELL BY PLACING "T" AFTER NUMBER (EG U-1927-ABT). A U-81 FITTING IS THEN ADDED TO PORT "A"</p> <p>MAXIMUM WORKING PRESSURE SEE FOOTNOTE*</p>														

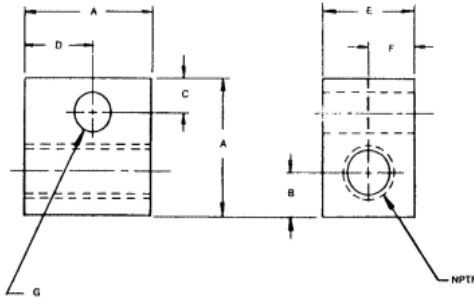
	THREADS		DIMENSIONS						
	BDI PART #	NPTF	A	B	C	D	E	F	G
Anchor Blocks Straight									
	BLK11689A	1/4	1-1/2	9/16	9/32	3/4	1	1/2	9/32
180° NPTF tapped holes	DRAWINGS								
									

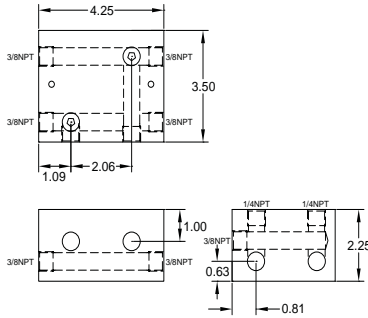
	BDI PART #	TYPE	OUTLETS (TUBE)	MOUNTING HOLES	
				#	Ø DIA.
Anchor Tee Pipe	U1022C	6 WAY	3/8NPT	2	11/32"
	DRAWINGS				
Includes mounting screws Max 6000psi for pipe					

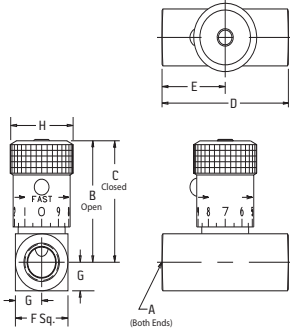
	BDI PART #	THREADS	PRESSURE	DIMENSIONS							
		NPTF	MAX PSI	A	B	C	D	E	F	G	H
Adjustable Needle Valve  Max Temp: -40° to 250°F (-40° to 121°C)	VAL14074A	1/2	5000	1/2NPTF	2.7"	2.42"	2.62"	1.31"	1.25"	0.62"	1.19"
	DRAWINGS										
											

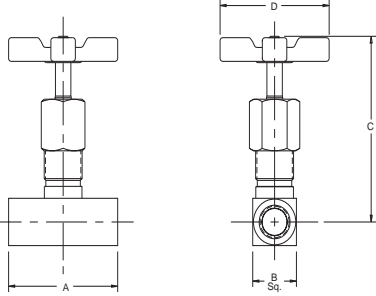
	BDI PART #	THREADS	PRESSURE	DIMENSIONS			
		NPTF	MAX PSI	A	B	C	D
Shut-off needle valve  Temp Range: 1/8 -40° to 300°F (-40° to 148°C) 1/4 -40° to 250°F (-40° to 121°C) 1/2 -40° to 500°F (-40° to 260°C)	B10233	1/8 NPT	600	1.75"	0.6"	1.875"	1.0"
	VAL13117A	1/4 NPTF	5000	2.0"	0.81"	3.21"	2.0"
	VAL11342A	3/8 NPTF	10,000	2.25"	1.37"	4.0"	2.25"
	U972D	1/2 NPTF	10,000	2.75"	1.12"	3.62"	2.50"
	DRAWINGS						
							

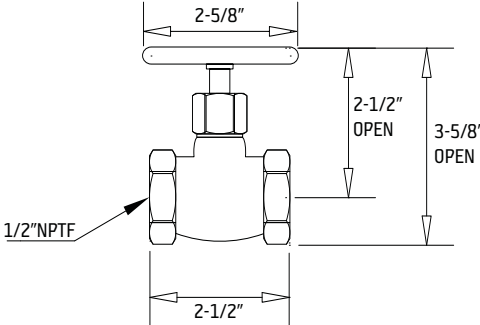
	BDI PART #	THREADS	PRESSURE	DIMENSIONS			
		NPTF	MAX PSI	A	B	C	D
Adjustable Flow Restrictor  Max Temp: 500°F (260°C)	LB9425	1/2	10,000 @70°	2.0"	0.81"	3.21"	2.0"
	DRAWINGS						
							

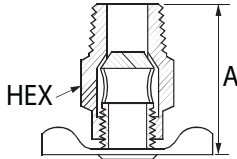
	BDI PART #	THREADS	PRESSURE	DIMENSIONS	
		NPT	MAX PSI	A	HEX
 <p>Brass Max Temp: 250°F (121°C)</p>	HP609	1/8NPT	150	0.8"	0.437"
	U127B	1/4NPT	150	1.41"	.562"
DRAWINGS					
					

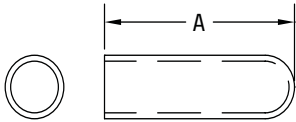
	BDI PART #	USED ON PRODUCT	MATERIAL	APPLICATION	A	
					INCH	MM
	U1732A	DD20	VINYL	INDICATOR STEM	1.25	31.7
	U1732D	DM30, DM40, FL-1, FL44			H.T. SILICON	1.5
	U1732E	DD50, DM50, FL11, FL45	VINYL			2.0
	U1732F	DM60			2.25	57.1
	27335	FL32, FL33, FL42, FL43		MEASURING CHAMBER	1.25	31.2
	CAP13896A	FL-1, FL44	ALUMINUM	INJECTOR BODY	3.25	82.6
	DRAWINGS					
						

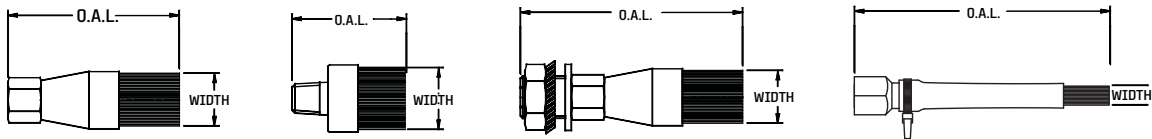
	BDI PART #	THREAD		O.A.L.	BRUSH		MATERIAL	STYLE	
		TYPE	SIZE		WIDTH	TYPE			
 <p>Temp. Range: Nylon -22° to 203° F (-30° to 95° C) Metal -22° to 572° F (-30° to 300° C)</p>	50955	FEMALE	1/8NPTF	3.75"	0.28"	ROUND	NYLON	4	
	35905	MALE	1/8NPT	2.3125"	1.0"	ROUND	STAINLESS STEEL	2	
	B7492	FEMALE	1/8NPTF	2.75"	0.75"	FLAT	NYLON	1	
	B7490	FEMALE	1/8NPTF	2.875"	0.75"	FLAT	NYLON	1	
	B7488	FEMALE	1/8NPTF	2.25"	0.75"	FLAT	NYLON	1	
	B7488L	FEMALE	1/8NPTF	2.25"	0.75"	FLAT	BRASS	1	
	803-10	MALE	1/8NPT	1.875"	1.0"	ROUND	NYLON	2	
	AR1473	FEMALE	1/8NPTF	2.25"	1.18"	FLAT	NYLON	1	
	803-11	MALE	1/8NPT	1.875"	1.75"	FLAT	NYLON	2	
	35935	MALE	1/8NPT	2.3125"	2.0"	FLAT	NYLON	2	
	35936	FEMALE	1/8NPT	5.3125"	4.5"	FLAT	NYLON	2	
	B7491	FEMALE	5/16-24	2.25"	0.75"	FLAT	NYLON	3	
	45398	MALE	1/8BSPP	49MM	10MM	ROUND	NYLON	2	
	73490-8283	FEMALE	M10X1	52MM	20MM	FLAT	NYLON	1	
	DRAWINGS								
									

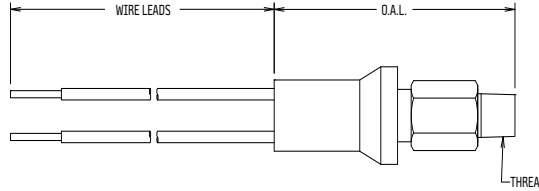
Pressure Switch Wire Leads	BDI PART #	PRESSURE		PRESSURE RANGE	THREAD	CONTACT		ELECTRIC CONN.	VOLTAGE RATING		SET POINT TYPE	ENCL. RATING	DIM O.A.L.
		PSI	BAR			STATE	TYPE		VOLTAGE	AMPS			
 <p>Temp Range: -40° to 225°F (-40° to 107°C)</p> <p>*Resistive</p>	26410	11	.75	FIXED	1/8NPT	N.O.	SPST	12" LEADS	250VAC	5	FALLING	IP65	2.6"
									30VDC	5*			
	32759	24	1.6	FIXED	1/8NPT	N.O./N.C.	SPDT	12" LEADS	250VAC	5	FALLING	IP65	2.1"
									30VDC	5*			
	26772	225	15.5	FIXED	1/8NPT	N.O.	SPST	18" LEADS	250VAC	5	RISING	IP65	2.2"
									30VDC	5*			
	19032	225	15.5	FIXED	1/8NPT	N.O.	SPST	12" LEADS	120VAC	5.8	RISING	IP65	2.1"
									240VAC	2.9			
									28VDC	2			
	35517-1	600	41	500-2000PSI	1/4NPT	N.O.	SPST	DEUTECH	250VAC	5	RISING	NEMA 4/13	3.6"
									30VDC	5*			
	35517-2	2000	137	1200-4500PSI	1/4NPT	N.O.	SPST	DEUTECH	250VAC	5	RISING	NEMA 4/13	3.6"
30VDC									5*				
DRAWINGS													
													

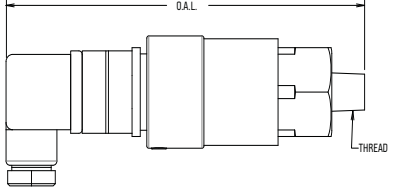
Pressure Switch DIN style	BDI PART #	PRESSURE		PRESSURE RANGE	THREAD	CONTACT		ELECTRIC CONN.	VOLTAGE RATING		SET POINT TYPE	ENCL. RATING	DIM O.A.L.
		PSI	BAR			STATE	TYPE		VOLTAGE	AMPS			
 <p>Temp Range: -40° to 225°F (-40° to 107°C)</p> <p>*Resistive</p>	26641-2	45	3.1	FIXED	1/8NPT	N.O.	SPST	DIN 43650A	125/250VAC	10	FALLING	IP65	4.0"
									30VDC	5			
	26641-3	55	3.8	FIXED	1/8NPT	N.O.	SPST	DIN 43650A	125/250VAC	10	RISING	IP65	4.0"
									30VDC	5			
	26772-2	225	15.5	FIXED	1/8NPT	N.O./N.C.	SPDT	DIN 43650A	125/250VAC	10	R/F	IP65	3.7"
									30VDC	5*			
	34210	300	20	FIXED	1/8NPT	N.O./N.C.	SPDT	DIN 43650A	125/250VAC	10	R/F	IP65	3.7"
									30VDC	5*			
	29171	739	51	145-1450	1/4NPT	N.O./N.C.	SPDT	DIN 43650A	250VAC	6	RISING	IP65	3.5"
	35859	2000	137	1200-4500PSI	1/4NPT	N.O.	SPST	DIN 43650A	250VAC	5	RISING	NEMA 4/13	5.4"
									30VDC	5*			
	35859-1	600	41	500-2000PSI	1/4NPT	N.O.	SPST	DIN 43650A	250VAC	5	RISING	NEMA 4/13	5.4"
30VDC									5*				
35652	3500	241	FIXED	1/4NPT	N.O./N.C.	SPDT	DIN 43650A	125/250VAC	5	RISING	IP65	5.3"	
								30VDC	5				
DRAWINGS													
													

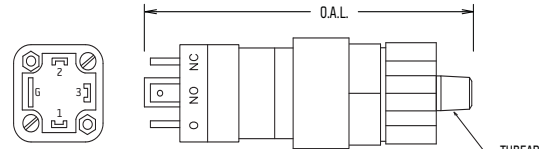
Pressure Switch Form 43650A DIN	BDI PART #	PRESSURE		PRESSURE RANGE	THREAD	CONTACT		ELECTRIC CONN.	VOLTAGE RATINGS		SET POINT TYPE	ENCL. RATING	DIM O.A.L.
		PSI	BAR			STATE	TYPE		VOLTAGE	AMPS			
	27445-3	1000	68.9	500-4700 PSI	1/4NPT	N.O./N.C	SPDT	DIN TERM A	5A(R)-5A(I) 125/250VAC 5A(R)-3A(I) 30VDC 0.5A(R)-0.25A(I) 125VDC 5mA 6VDC 2mA 12VDC 1mA 24VDC		RISING	NEMA 4	4.4"
	27444-1	50	3.4	4-50 PSI	1/8NPT	N.O./N.C.	SPDT	DIN TERM A			RISING	NEMA 4	4.1"
	27444-2	70	4.8	15-150 PSI	1/8NPT	N.O./N.C	SPDT	DIN TERM A			RISING	NEMA 4	4.1"
	27444-3	100	6.8	30-600 PSI	1/8NPT	N.O./N.C.	SPDT	DIN TERM A			RISING	NEMA 4	4.1"
	35409	1500	103	FIXED	1/4NPT	N.O./N.C	SPDT	DIN TERM A	250VAC	5	RISING	NEMA 4	4.1"
DRAWINGS													
													

Temp Range:
0° to 160°F
(-18° to 71°C)

See page 72 for DIN
Connectors

*Resistive

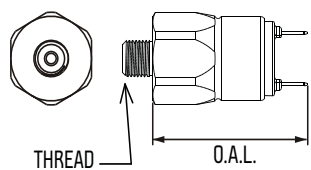
Pressure Switch Spade style	BDI PART #	PRESSURE		PRESSURE RANGE	THREAD	CONTACT		ELECTRIC CONN.	VOLTAGE RATINGS		SET POINT TYPE	ENCL. RATING	DIM O.A.L.
		PSI	BAR			STATE	TYPE		VOLTAGE	AMPS			
	26393	7	.48	FIXED	1/8NPT	N.C.	SPST	2 SPADES	250VAC	5	FALLING	IP65	2.6"
	HE825	10	.68	FIXED	1/8NPT	N.O.	SPST	2 SPADES	30VDC	5*	RISING	-	1.9"
	HE855	10	.68	FIXED	1/8NPT	N.C.	SPST	2 SPADES	240VAC	5	RISING	-	1.9"
	23545	20	2	FIXED	1/8NPT	N.O.	SPST	2 SPADES	220VAC	4	RISING	IP65	2.16"
								42VDC					
	23536	230	16	FIXED	1/8NPT	N.O.	SPST	2 SPADES	42VDC	4*	RISING	IP65	2.2"
	23472	290	20	FIXED	1/8NPT	N.O.	SPST	2 SPADES	220VAC	4	RISING	IP65	2.2"
								42VDC					
34241-8823	217	15	145-725PSI	M10X1T	N.O./N.C.	SPDT	4 SPADES	250VAC	4	RISING	IP65	2.3"	
DRAWINGS													
													

Temp Range:
-40° to 225°F
(-40° to 107°C)

*Resistive

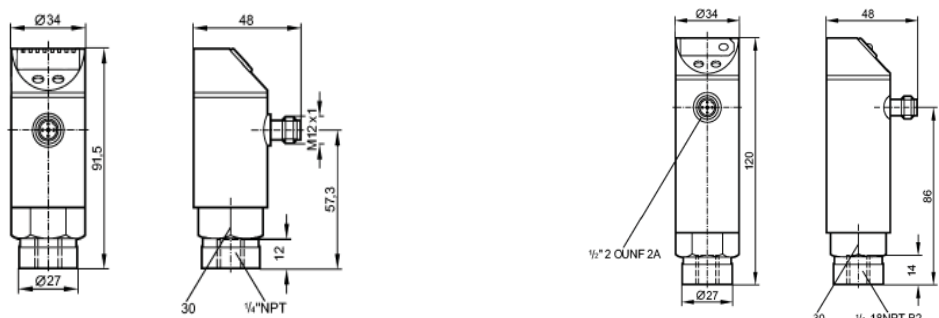
Pressure Switch Digital	BDI PART #	PRESSURE			THREAD	CONTACT STATE	ELECTRIC CONN.	MAX VOLTAGE	AMPS @MAX	ENCL. RATING	DIM O.A.L.	ENCL. RATING	DIM O.A.L.
		PSI	BAR	MPa									
	29921	10-1440	0-100	0-10	1/4NPTF	N.O./N.C PNP	M12 4POLE	18-36VDC	250mA	IP67	3.6"	NEMA 4	4.4"
	34312	10-1440	0-100	0-10	1/4NPTF	N.O./N.C.	1/2-UNF 5PIN	90-250VAC	2.5	IP67	4.7"	NEMA 4	4.1"
DRAWINGS													
													

Temp Range:
-40° to 225°F
(-40° to 107°C)

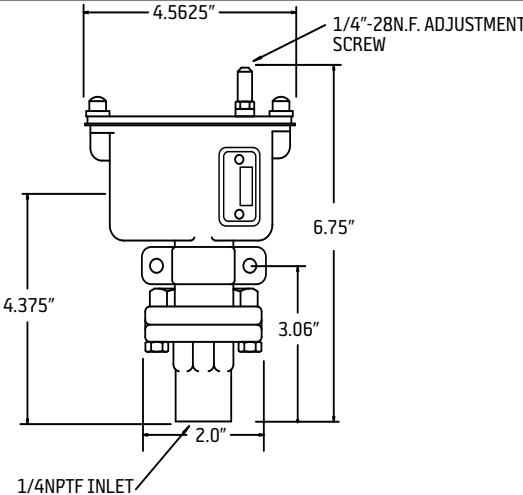
BDI PART #	DECREASING PRESSURE		INCREASING PRESSURE		DEAD-BAND	PROOF PRES-SURE	THREAD	CONTACT		ELEC. CONN.	VOLTAGE RATING (CONTINUOUS INDUCTIVE)		
	PSI	BAR	PSI	BAR				STATE	TYPE		VOLTAGE	AMPS	
Pressure Switch 	U620D1	250-2650	17-180.3	280-3000	19-204.1	30-350 PSI	7000 PSI	1/4NPTF	N.O./N.C.	SPDT	1/2NPTF	125/250/480VAC	10
													6VDC
DRAWINGS													
													
<p>NEMA 3 UL & CSA</p> <p>Temp Range: -20° to 165°F (-29° to 74°C)</p>													

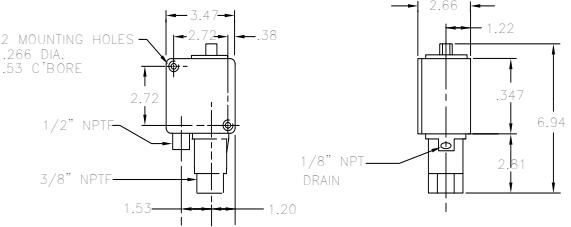
BDI PART #	PRESSURE		ACTUATION DIFFERENTIAL	MAX SURGE	THREAD	CONTACT		ELEC. CONN.	VOLTAGE (INDUCTIVE)		
	PSI	BAR				STATE	TYPE		VOLTAGE	AMPS	
Pressure Switch 	U6636	400-3000	27.5-206.8	210-400 PSI	10000PSI	3/8NPTF	N.O./N.C.	SPDT	1/2NPTF	110VAC	15
										220VAC	10
										440VAC	6
										115VDC	0.25
DRAWINGS											
											
<p>NEMA 4 & 13 UL, CSA, CE</p> <p>Temp Range: 14° to 122°F (-10° to 50°C)</p>											

	BDI PART #	PRESSURE		THREAD	CONTACT		ELECTRIC CONNECTION	VOLTAGE RATING (RESISTIVE)		APPROX. DEAD-BAND
		PSI	BAR		STATE	TYPE		VOLTAGE	AMPS	
Pressure Switch	26792	3-100	0.2-6.9	1/4NPTF	N.O./N.C.	SPDT	1/2NPTF & 7/8 KNOCKOUT(2)	125/250/480VAC	15	1 TO 4PSI
	26793	9-300	0.6-20.7	1/4NPTF	N.O./N.C.	SPDT	1/2NPTF & 7/8 KNOCKOUT(2)	125/250/480VAC	15	1 TO 5PSI
DRAWINGS										



NEMA 4X
UL, CSA & CE

Temp Range:
-40° to 160°F
(-40° to 71°C)

	BDI PART #	PRESSURE		PRESSURE RANGE	THREAD	CONTACT		ELEC. CONN.	VOLTAGE (RESISTIVE)		SET POINT TYPE	DIM O.A.L.
		PSI	BAR			STATE	TYPE		VOLTAGE	AMPS		
Pressure Switch Open Frame	HE829	10	.69	0-240 PSI	1/8NPT	N.O./N.C.	SPDT	3-TERM	125/250VAC	15	RISING	3.375"
DRAWINGS												



UL, cUL, CE

Temp Range:
-40° to 160°F
(-40° to 71°C)

BDI PART #	DECREASING PRESSURE		INCREASING PRESSURE		THREAD	CONTACT		ELEC. CONN.	VOLTAGE	AMPS	ENCL. RATING	
	PSI	BAR	PSI	BAR		STATE	TYPE					
Pressure Switch Explosion Proof Diaphragm  Dual Set Point UL/CSA Temp Range: -65° to 165°F (-54° to 74°C)	SWT13299A	1.5-144	0.1-9.8	7.5-150	0.5-102	1/4NPTF	N.O./N.C.	SPDT	3/4NPTF	125/250VAC	10	NEMA 4,7,9
		480VAC	3									

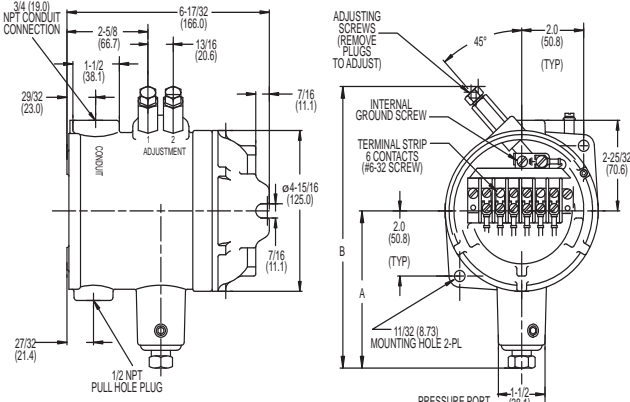

BDI PART	PRESSURE RANGE		PRESSURE RATINGS(PSI)			THREAD	CONTACT		CONNECTION	VOLTAGE	AMPS	
	PSI	BAR	STATIC	PROOF	DEADBAND		STATE	TYPE				
Pressure Switch Explosion Proof  XP Div 1&2 UL, CSA NEMA 7/9, IP66 Temp Range: 0° to 150°F (-17° to 65°C)	24383	10-100	.69-6.9	1000	4000	4-10	1/4NPTF	N.O./N.C.	SPDT	1/2NPTF (3/4NPT BUSH-ING)	125/250VAC	15

DRAWINGS

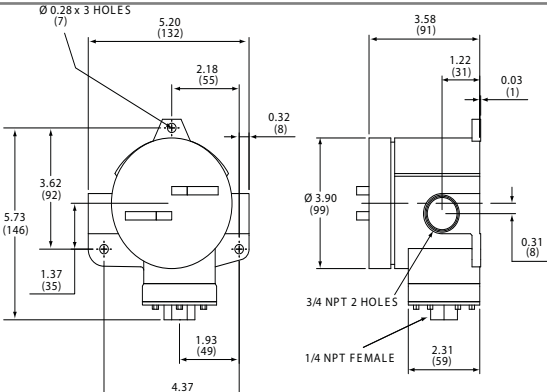

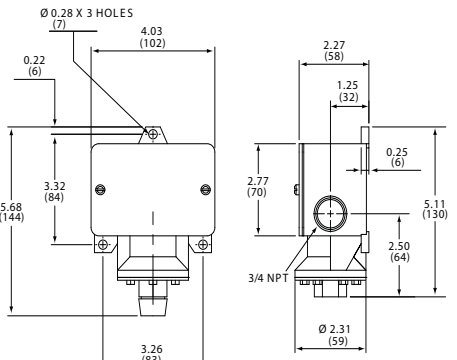

BDI PART #	PRESSURE RANGE		PRESSURE RATINGS(PSI)			THREAD	CONTACT		ELEC. CONN.	VOLTAGE	AMPS	
	PSI	BAR	STATIC	PROOF	DEADBAND		STATE	TYPE				
Pressure Switch  NEMA 3,4,4X,13, IP66 UL, CSA Temp Range: 0° to 150°F (-17° to 65°C)	26084	0-60	0-4.1	500	2000	2-4PSI	1/2NPTF	N.O./N.C.	SPDT	1/2NPTF	125/250VAC	15
	17915	40-200	2.7-13.7	1000	4000	5-15PSI	1/4NPTF	N.O./N.C.	SPDT	1/2NPTF	125/250VAC	15

DRAWINGS

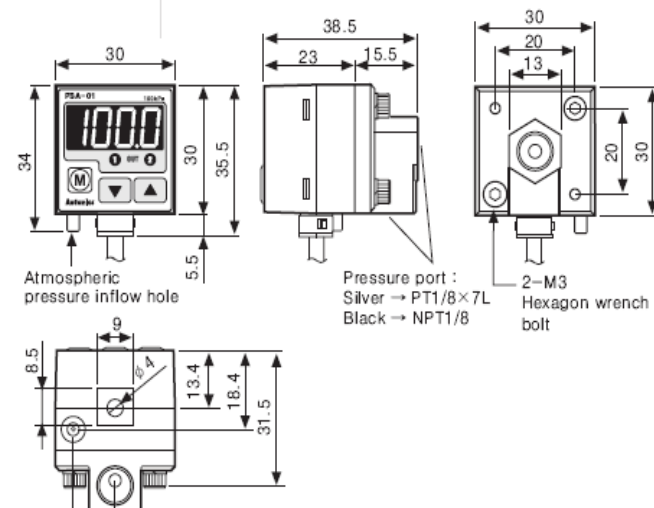

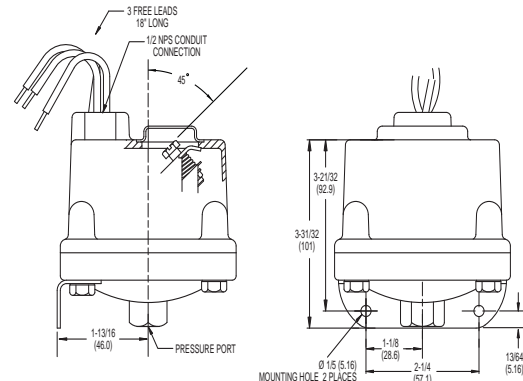

	BDI PART #	PRESSURE		THREAD	CONTACT		ELECTRIC CONN.	MAX VOLTAGE	AMPS @MAX	ELEC. RATING	DIM O.A.L.	NOTES
		PSI	BAR		STATE	TYPE						
Air Pressure Switch Digital  CE Temp Range: 14° to 122°F (-10° to 50°C)	71925	0-145	0-10	1/8BSPT	N.O./N.C	PNP	CABLE GLAND(4MM)	12-24VDC	50mA	IP40	1.6"	DIGITAL
	DRAWINGS											
 <p>Atmospheric pressure inflow hole</p> <p>Pressure port : Silver → PT1/8×7L Black → NPT1/8</p> <p>2-M3 Hexagon wrench bolt</p>												

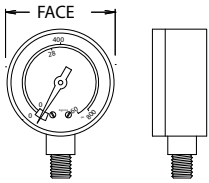
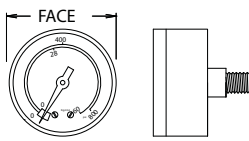
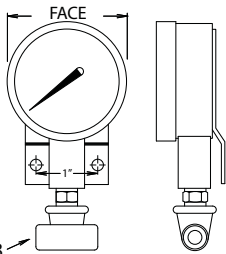

	BDI PART #	PRESSURE		THREAD	CONTACT		ELEC. CONN.	VOLTAGE RATING (INDUCTIVE)		ENCL. RATING	DIM O.A.L.	WIRE CODING
		PSI	BAR		STATE	TYPE		VOLTAGE	AMPS			
Air Pressure Switch Diaphragm  Temp Range: -65° to 165°F (-54° to 74°C)	U623	1.5-150	.1-10	1/4NPTF	N.O./N.C.	SPDT	1/2NPTF	125/250VAC	10	NEMA 4	4.0"	RED = N.O. BLUE = N.C. PURPLE = COMMON
								460VAC	3			
								28VDC	5			
DRAWINGS												
 <p>3 FREE LEADS 18" LONG</p> <p>1/2 NPS CONDUIT CONNECTION</p> <p>45°</p> <p>1-13/16 (46.0)</p> <p>PRESSURE PORT</p> <p>3-21/32 (92.9)</p> <p>3-31/32 (101)</p> <p>1-1/8 (28.6)</p> <p>2-1/4 (57.1)</p> <p>13/64 (5.16)</p> <p>Ø 1/5 (5.16)</p> <p>MOUNTING HOLE 2 PLACES</p>												

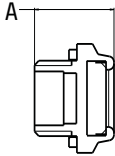
	BDI PART #	SCALE				FACE Inch	MOUNT TYPE	THREAD SIZE	PRESSURE FINGER	LIQUID FILLED	BRACKET 1" CENTER	NOTES
		psi	bar	kPa	kg-cm ²							
	B4310	30	2	-	-	2"	LM	1/8NPTF	NO	NO	YES	
	26367	60	-	-	-	2"	LM	1/8NPTF	NO	NO	YES	INCL RED-ZONE 0-15PSI
	26336	60	-	-	-	2"	LM	5/16-24F	NO	NO	YES	INCL RED-ZONE 0-15PSI
	32806	100	-	-	-	1.5"	CBM	1/8NPT	NO	NO	NO	
	B10114	100	7	-	-	1.75"	CBM	1/8NPT	NO	NO	NO	
	B4340	100	7	-	-	2"	LM	1/8NPTF	NO	NO	NO	
	B4363	100	7	-	-	2"	LM	1/8NPTF	NO	NO	YES	
	B5609	100	7	-	-	2"	LM	1/8NPTF	YES	NO	NO	
	B5610	100	7	-	-	2"	LM	1/8NPTF	YES	NO	YES	
	B4691	100	7	-	-	2.5"	CBM	1/8NPT	NO	NO	NO	PANEL MOUNT/90° FTG GAUGE
	B6920	100	7	-	-	2.5"	CBM	1/8NPT	NO	NO	NO	PANEL MOUNT
	B4745	100	-	-	-	2"	LM	5/16-24	NO	NO	YES	
	B5612	100	7	-	-	2"	LM	5/16-24	YES	NO	YES	
	B4364	100	7	-	-	2"	LM	5/16-24F	NO	NO	YES	INCL JUNCTION B1503
	B4360	100	7	-	-	2"	LM	5/16-24F	NO	NO	YES	
	B5613	100	7	-	-	2"	LM	5/16-24F	YES	NO	YES	INCL JUNCTION B1503
	B5611	100	7	-	-	2"	LM	5/16-24F	YES	NO	YES	
	32657	160	11	-	-	1.5"	CBM	1/8NPT	NO	NO	NO	INCL SCALE: Hg 0-30"
	27228	160	-	-	11	1.5"	CBM	1/8NPT	NO	NO	NO	
	F275Y160M	160	11	-	-	2"	CBM	1/4NPT	NO	NO	NO	
	23522	160	11	-	-	2"	LM	1/8NPT	NO	NO	NO	
	U902H	160	11	-	-	2.62"	LM	1/8NPT	NO	YES	NO	
	23572	160	11	-	-	38MM	CBM	1/8NPT	NO	NO	NO	
	B3839	200	14	-	-	2"	LM	1/8NPTF	NO	NO	NO	
	B4581	200	14	-	-	2"	LM	1/8NPTF	YES	NO	NO	
	B4583	200	14	-	-	2"	LM	1/8NPTF	YES	NO	YES	INCL JUNCTION B1503
	B5614	200	14	-	-	2"	LM	1/8NPTF	YES	NO	YES	
	B4895	200	14	-	-	2"	LM	5/16-24	YES	NO	YES	
	B4582	200	14	-	-	2"	LM	5/16-24F	YES	NO	YES	
DRAWINGS												
LM - LOWER MOUNT			CBM - CENTER BACK MOUNT			LM - GAUGE WITH BRACKET						
												
						B1503 JUNCTION						

	BDI PART #	SCALE					FACE Inch	MOUNT TYPE	THREAD SIZE	PRESSURE FINGER	LIQUID FILLED	BRACKET 1" CENTER	NOTES
		psi	bar	kPa	kg-cm ²	MPa							
Pressure Gauges (Continued) 	B7311	200	-	-	-	-	2.5"	CBM	1/8NPT	NO	NO	NO	PANEL MOUNT
	A4297	300	-	-	-	-	1.5"	LM	1/8NPT	NO	NO	NO	
	60528	300	20	-	-	-	1.5"	LM	1/8NPT	NO	YES	NO	
	23821	360	25	-	-	-	40MM	CBM	1/8NPT	NO	NO	NO	
	75111M015	360	25	-	-	-	63MM	CBM	1/4BSPP	NO	YES	NO	
	B9971	400	28	-	-	-	1.5"	LM	1/8NPT	NO	NO	NO	
	75111-2323	-	40	-	-	-	40MM	LM	6MM-T	NO	NO	NO	6MM STANDPIPE CONNECTION
	23814	580	40	-	-	-	40MM	CBM	1/8NPT	NO	NO	NO	
	19721	600	40	-	-	-	1.5"	LM	1/8NPT	NO	NO	NO	
	21807	800	-	-	60	-	2"	LM	1/8NPT	NO	NO	NO	
	27620	800	56	-	-	-	2"	LM	1/8NPT	NO	NO	NO	
	23411	870	70	-	-	-	2"	LM	1/8NPT	NO	NO	NO	
	24541	1000	70	-	-	-	1.5"	CBM	1/8NPT	NO	NO	NO	
	23795	1000	69	-	-	-	1.5"	CBM	1/8NPT	NO	NO	NO	3PH KIT FOR SF PDI
	20134	1000	-	-	70	-	2"	LM	1/8NPT	NO	NO	NO	
	U902J	2000	140	-	-	-	2.12"	LM	1/8NPT	NO	YES	NO	
	U902D	3000	200	-	-	-	2.62"	LM	1/4NPT	NO	YES	NO	
	U902DB	3000	200	-	-	-	2.62"	CBM	1/4NPT	NO	NO	NO	
	U902F	5000	350	-	-	-	2.62"	LM	1/4NPT	NO	YES	NO	
	U902FB	5000	350	-	-	-	2.62"	CBM	1/4NPT	NO	YES	NO	
GAG13347A	5000	-	34000	-	-	4"	LM	1/4NPT	NO	YES	NO		
751119463	-	400	-	-	-	62MM	LM	1/4BSPP	NO	YES	NO		
30886-16	9000	-	35000	-	60	2.62"	LM	1/4BSPT	NO	YES	NO		
30854-12	3625	-	-	-	25	71.3MM	CBM	1/4BSPT	NO	NO	NO		

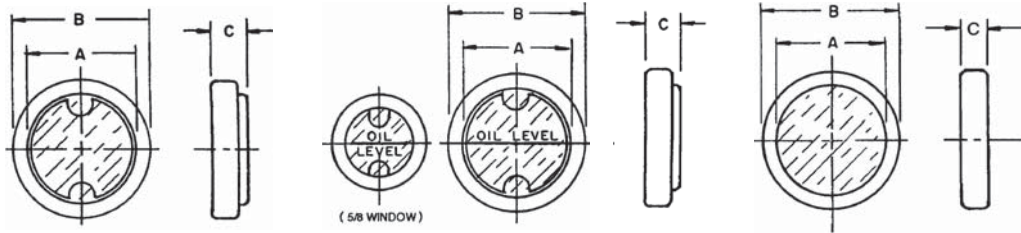
	BDI PART #	THREADS	PRESSURE MAX PSI	HEX SIZE	LENS DIAMETER	DIMENSION A	LENS MATERIAL	PLUG MATERIAL
Oil Level Sight Plugs  Max temp: LSPB 500°F (260°C) AX 266°F (130°C)	LSPB 38	3/8NPT	400	3/4"	7/16"		GLASS	COLD ROLLED STEEL
	LSPB 50	1/2NPT	250	7/8"	5/8"			
	LSPB 75	3/4NPT	200	1-1/8"	3/4"			
	LSPB 100	1NPT	100	1-3/8"	1"			
	LSPB 125	1-1/4NPT	60	1-3/4"	1-3/16"			
	AX21145	1/4BSPP	58	17mm	8mm	15mm	PLEXI-GLASS	ALUMINUM
	AX21150	3/8BSPP		22mm	11mm	16mm		
	AX21155	1/2BSPP		27mm	15mm	17mm		
	AX21160	3/4BSPP		32mm	20mm	20mm		
	AX21165	1BSPP		40mm	25mm	24mm		
AX21170	1/4BSPP	50mm	33mm	24mm				
AX21175	1/2BSPP	55mm	38mm	24mm				
DRAWINGS								
								

	BDI PART #	DIMENSIONS			TYPE	NOTES (Previous Plastic Style BIJUR Part Number:)	
		I.D.(A)	O.D.(B)	W.(C)			
 <p>Window Units</p> <p>Material: Glass window Corrosion-resistant plated</p> <p>Max Temperature: 300°F (148°C)</p>	B5184	5/8"	7/8"	19/64"	Standard	B4900	
	B5944	5/8"	7/8"	19/64"	Level	B5095	
	B5602	5/8"	7/8"	19/64"	Open	B5104	
	B5108	1"	1-1/4"	11/32"	Standard	B4904	
	B5631	1"	1-1/4"	11/32"	Level	B5093	
	B5603	1"	1-1/4"	11/32"	Open	B5102	
	B5145	1-1/4"	1-1/2"	3/8"	Standard	B4908	
	B5734	1-1/4"	1-1/2"	3/8"	Level	B5091	
	B5604	1-1/4"	1-1/2"	3/8"	Open	B5100	
	B5582	1-3/4"	2"	3/8"	Standard	B5171	
	B5191	1-3/4"	2"	3/8"	Level	B5175	
	B5605	1-3/4"	2"	3/8"	Open	B5177	
	20233	1-3/4"	2"	3/8"	Level		
	0396021	1-3/4"	2"	3/8"	Lubriport		
	B8265	1-3/4"	2"	3/8"	Open		
	DRAWINGS						
							
	STANDARD		LEVEL			OPEN	

Nozzles	BDI PART #	INLETS		TYPE	SPRAY PATTERN	ORIFICE SIZE	FIGURE	NOTES	
		AIR	OIL						
  	AR1758	1/4BSPP	1/4BSPP	GREASE	ROUND		1	BRASS, MAX 500PSI	
	U922C	1/4NPTF	1/4NPTF	GREASE	ROUND		1	BRASS, MAX 500PSI	
	U922C-SS	1/4NPTF	1/4NPTF	GREASE	ROUND		1	STAINLESS STEEL, MAX 500PSI	
	U922D	1/4NPTF	1/4NPTF	GREASE	ROUND		1	CLEAN OUT TYPE, MAX 500PSI	
	U987	-	-	-	-	-	-	-	WALL MOUNT ADAPTER FOR U922 (3/4"NPT)
	U943C	-	-	GREASE	ROUND		1	REPLACEMENT NOZZLE FOR U922C	
	U943F	-	-	GREASE	FLAT		1	ALTERNATE NOZZLE FOR U922C	
	SDU01A00000	10mm	10mm	GRS/OIL	FLAT / STR		2	SDU Also available with monitoring &/or heating	
	SDU03A00000	10mm	10mm	GRS/OIL	FLAT / 90°		2		
	SDU02A00000	10mm	10mm	GRS/OIL	ROUND / STR		2		
SDU04A00000	10mm	10mm	GRS/OIL	ROUND / 90°		2			
	27107-1	-	5/16-24(F)	OIL	ROUND	2.5MM	3	AIR/OIL	
	27107-3	-	5/16-24(F)	OIL	ROUND	2.0MM	3	AIR/OIL	
	B5384	-	1/8NPT	OIL	ROUND	0.0145"	4		
	73654-2151	-	4MM TUBE	OIL	ROUND	1.0MM	5	250MM OAL	
	73654-2141	-	4MM TUBE	OIL	ROUND	1.0MM	5	150MM OAL	

DRAWINGS

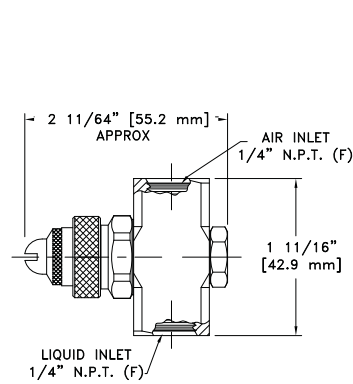
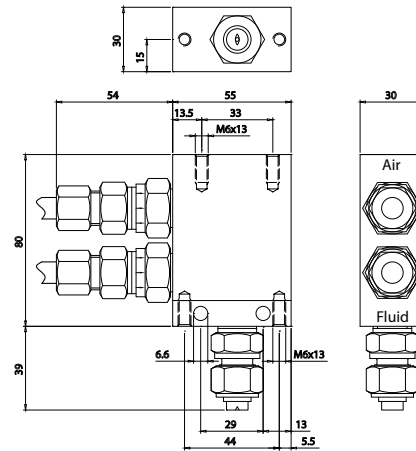

FIGURE 1



SDU measurements shown in mm.

FIGURE 2

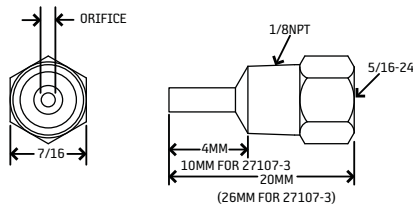

FIGURE 3

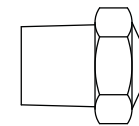

FIGURE 4

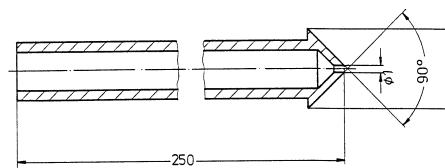

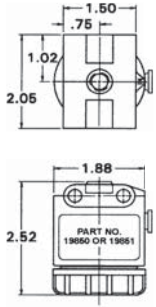
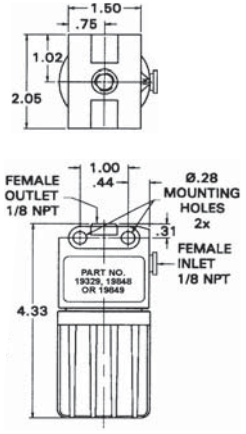

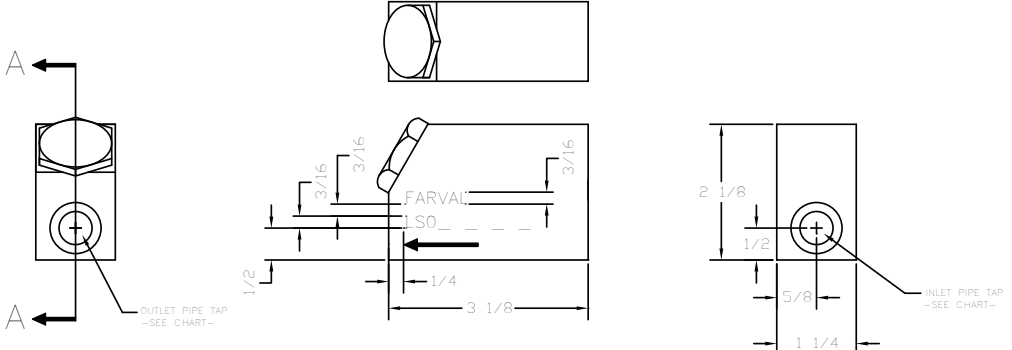







FIGURE 5

	BDI PART #	MICRON	SIZE	THREADS		REPLACEMENT ELEMENT	REPLACES OLD BIJUR FILTER PART NUMBER:
				INLET	OUTLET		
Inline Filters High Pressure  Max Pressure: 500 psi	43252	5	1"	1/8NPTF	1/8NPTF	43254	-
	19850	25	1"	1/8NPTF	1/8NPTF	B6527	B7239
	19851	125	1"	1/8NPTF	1/8NPTF	B6530	B7243
	19329	10	3"	1/8NPTF	1/8NPTF	19325	-
	19848	25	3"	1/8NPTF	1/8NPTF	B6890	B7254
	19849	125	3"	1/8NPTF	1/8NPTF	B6889	B7257
DRAWINGS							
1" Filter Assembly				3" Filter Assembly			
							

	BDI PART #	MICRON	THREADS		MEDIA	INDICATOR	SWITCH	REPLACEMENT SCREEN
			INLET	OUTLET				
Strainers  Max Pressure: 5000 psi Flow Value: 2 gpm	LS02103	25	1/4NPTF	1/4NPTF	OIL UP TO 500SSU	NO	NO	LS0205103
	LS03103	25	3/8NPTF	3/8NPTF	OIL UP TO 500SSU	NO	NO	LS0205103
	LS02106	150	1/4NPTF	1/4NPTF	OIL UP TO 2000SSU	NO	NO	LS0205106
	LS03106	150	3/8NPTF	3/8NPTF	OIL UP TO 2000SSU	NO	NO	LS0205106
	LS02120	500	1/4NPTF	1/4NPTF	OIL OVER 2000SSU & ALL GREASE	NO	NO	LS0205120
	LS03120	500	3/8NPTF	3/8NPTF	OIL OVER 2000SSU & ALL GREASE	NO	NO	LS0205120
LS03220	500	3/8NPTF	3/8NPTF	OIL OVER 2000SSU & ALL GREASE	YES	NO	LS0205120	
DRAWINGS								
								

	BDI PART #	MICRON	SIZE	THREADS		FLOW VALUE (Φ)	REPLACEMENT ELEMENT
				INLET	OUTLET		
Inline Filters  Max Pressure: 300 psi	D3489	3	7.375"	1/2NPTF	1/2NPTF	400,000	B9830
	D3527	12	7.375"	1/2NPTF	1/2NPTF	1,000,000	B9832
	D3467	25	7.375"	1/2NPTF	1/2NPTF	1,200,000	B9765
DRAWINGS							

	BDI PART #	MICRON	MAX FLOW	THREADS		OIL VISCOSITY	MAX PRESSURE
				INLET	OUTLET		
Inline Filters Stainless Steel  Max Temperature: -320°F TO 800°F (-196°C TO 427°C)	26487	5	5 GPM	1/8NPT	1/8NPTF	100-2000 SSU	6000 PSI
DRAWINGS							

	BDI PART #	DIMENSIONS			NOTES
		A	B	C	
Fill Strainers    	32116-1	37mm	34mm	35.5mm	USED WITH CAP 32114
	19030	1.10"	0.86"	2.0"	USED WITH HF705C
	35150	49mm	27mm	127mm	ASSEMBLY USED ON SURFIRE I SINGLE PHASE (Includes fill cap, gaskets & screws)
	23915	41.5mm	37.5mm	124mm	ASSEMBLY USE ON SUREFIRE I - 3 PHASE (Includes fill cap)
	27073	82.7mm	46.5mm	126.5mm	ASSEMBLY USED ON LARGE SIZE RESERVOIRS
	71121	30.5mm	27.5mm	110mm	ASSEMBLY USED ON SURFIRE II (Includes fill cap, chain and oring)
DRAWINGS					

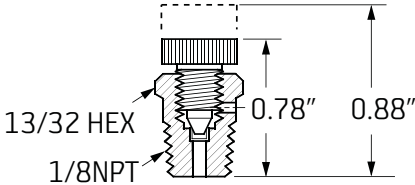
	BDI PART #	MAX PSI	THREADS	NOTES
Air Vent Valve  Max Temperature: -65°F TO 250°F (-53°C TO 121°C)	U129	150	1/8NPT	
	DRAWINGS			
				

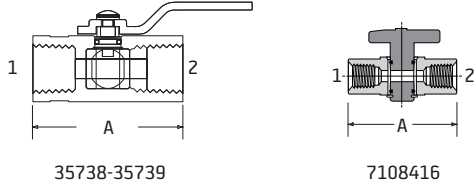
	BDI PART #	THREADS		DIMENSION "A"	MAX PSI	MATERIAL
		Female (1)	Female (2)			
Ball Valves  Max Temperature: -40°F TO 300°F (-40°C TO 150°C) (Max 175°F/7108416)	35738	1/4NPTF	1/4NPTF	1.75"	600	BRASS
	35739	1/8NPTF	1/8NPTF	1.875"	1000	BRASS
	7108416	1/4NPTF	1/4NPTF	2.10"	250	BRASS
	37161	3/8NPTF	3/8NPTF	2.87"	7000	STEEL
DRAWINGS						
						

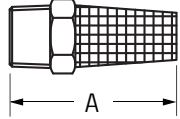
	BDI PART #	MAX PSI	THREADS	DIMENSIONS		NOTES
				A	HEX	
Muffler Filter  Max Temperature: 40°F TO 300°F (4°C TO 148°C)	A4239-M	300	1/8NPT	1-1/8"	7/16"	
	A4239-1	300	1/4NPT	1-3/8"	9/16"	
	A4239-3	300	1/2NPT	1-7/8"	7/8"	
	33007	300	1/8BSPP	27MM	12MM	
DRAWINGS						
						

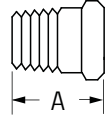
	BDI PART #	MAX PSI	THREADS	DIMENSIONS		NOTES
				A	HEX	
Breather Filter Vents  Max Temperature: 40°F TO 300°F (4°C TO 148°C)	A4256	150	1/8NPT	7/16"	7/16"	
	A4256-1	150	1/4NPT	5/8"	9/16"	
	A4256-2	150	3/8NPT	3/4"	11/16"	
	A4256-3	150	1/2NPT	7/8"	7/8"	
	31875	150	1/4BSPP	14.5MM	16MM	
DRAWINGS						
						

	BDI PART #	THREADS				RECOMMENDED LUBRICANTS	
		AIR INLET	VENT PORT	LUBE SUPPLY(X2)	ALT LUBE SUPPLY		
 Maximum Lubricant Pressure: 3800psi (262bar) Maximum Air Pressure: 120psi (8bar) Minimum Air Pressure: 40psi (3bar)	13850	1/4NPTF	1/4NPTF	3/4NPTF	-	OIL TO NLGI # 2 GREASE	
	27708	1/8NPTF	1/8NPTF	1/4NPTF	3/8NPTF	OIL TO NLGI # 1 GREASE	
	27926	1/8BSPP	1/8BSPP	1/4BSPP	3/8NPTF	OIL TO NLGI # 1 GREASE	
	32087	1/4NPTF	1/4NPTF	3/4NPTF	-	13850 VALVE WITH HOSE ASSEMBLIES FOR DRUM PUMPS	
DRAWINGS							

	BDI PART #	THREADS	"A"	NOTES
 Max Temperature: -40°F TO 239°F (-40°C TO 115°C)	19360-4	LTF16	42.2mm	
	19360-5	LTF1/2	43.7mm	
	34681	M20X1.5P	35mm	Used on Surefire
	DRAWINGS			

	BDI PART #	TYPE	STYLE	TYPE	CONNECTION	CABLE O.D.	MAX CURRENT	WIRES
 Temp. Range: -67° to 257° F (-55° to 125° C)	35559	DEUTSCH 2-WAY PLUG	STR	2 POLE	25'-FT.	0.198"	13 AMPS	RED/BLK
	35597	DEUTSCH 2-WAY PLUG	STR	2 POLE	25'-FT.	0.365"	13 AMPS	RED/BLK
	DRAWINGS							

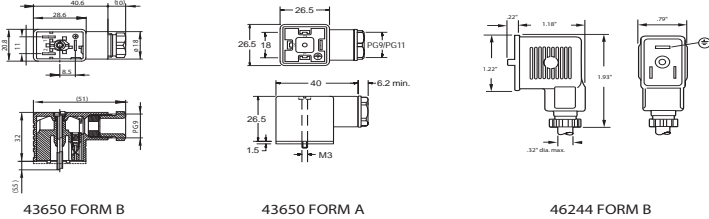
	BDI PART #	DIN	FORM	TYPE	CONNECTION	MAX WIRE DIA.	MAX VOLTAGE	MAX CURRENT	CONTACTS
DIN Connectors  Temp. Range: -13° to 194° F (-25° to 90° C) Protection: NEMA 4/IP65	MCC2509A	43650	B	GROUND UP	PG9	0.18"-0.275"	300VDC/250VAC 50/60Hz	10 AMPS	2 + GROUND
	MCC2510A	43650	A	GROUND UP	PG-11	0.31"-0.39"	300VDC/250VAC 50/60Hz	10 AMPS	3 + GROUND
	35621	46244	B	GROUND DOWN	Pg9P	0.32"	300VDC/250VAC 50/60Hz	10 AMPS	2 + GROUND
DRAWINGS									
									

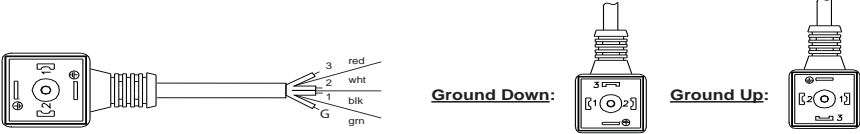
	BDI PART #	DIN	FORM	TYPE	WIRE	WIRE LENGTH	MAX VOLTAGE	MAX CURRENT	CONTACTS
DIN Connectors With Cables  Temp. Range: -13° to 194° F (-25° to 90° C) Protection: NEMA 4/IP65 NEMA 6/IP67(35732)	35732-1	43650	A	GROUND UP	AWG 18/4	15'-FT.	300VDC/250VAC 50/60Hz	10 AMPS	3 + GROUND
	35732-2	43650	A	GROUND DOWN	AWG 18/4	15'-FT.	300VDC/250VAC 50/60Hz	10 AMPS	3 + GROUND
	DIN14538-2	43650	A	GROUND DOWN	AWG 18/3	3'-FT.	300VDC/250VAC 50/60Hz	10 AMPS	2 + GROUND
	35623	46244	B	GROUND DOWN	AWG 18/2	10'-FT.	300VDC/250VAC 50/60Hz	10 AMPS	2 + GROUND
	35623-22	46244	B	GROUND DOWN	AWG 18/2	22'-FT.	300VDC/250VAC 50/60Hz	10 AMPS	2 + GROUND
	32847	43650	A	GROUND DOWN		6.5'-FT.	300VDC/250VAC 50/60Hz	10 AMPS	3 + GROUND
DRAWINGS									
									

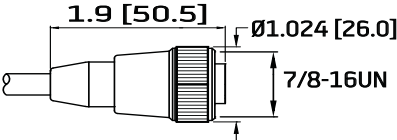
	BDI PART #	TYPE	LENGTH	CONNECTION	WIRE	MAX VOLTAGE	MAX CURRENT	NOTES
Automotive Type Connectors with Cable - BH/CH  Temp. Range: -4° to 221° F (-20° to 105° C) Protection: NEMA 6/IP68	MCC2505A	FEMALE	6'-FT.	3 PIN	AWG 18/3	300VDC/250VAC 50/60Hz	9 AMPS	
	MCC2505B	FEMALE	12'-FT.	3 PIN	AWG 18/3	300VDC/250VAC 50/60Hz	9 AMPS	
DRAWINGS								
								

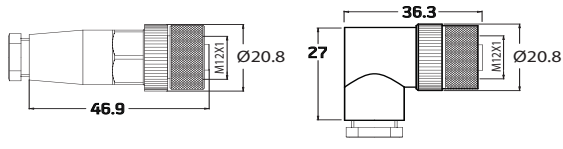

	BDI PART #	AWG	CONDUCTORS	UL/CSA TYPE	VOLTAGE	O.D.	WIRE COLORS
Electric Cables  Temp. Range: -40° to 194° F (-40° to 90° C)	15117-1	18	3	SJO	300V	0.320"	GREEN/WHITE/BLACK
	15117-2	18	2	SVO	300V	0.238"	WHITE/BLACK
	15117-5	16	4	SJO	300V	0.365"	RED/GREEN/WHITE/BLACK
	35563	16	2	UL-CL3R	300V	0.198"	RED/BLACK
	HE973	18	1	AWM/TEW	600V	0.112"	RED

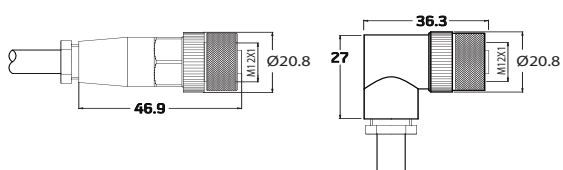
	BDI PART #	TYPE	STYLE	M12 TYPE	CONNECTION	MAX VOLTAGE	MAX CURRENT	NOTES
M12 Connectors Field Attachable 	23694	FEMALE	STR	5 POLE	PG11	60V AC/DC	4 AMPS	
	23694-1	FEMALE	90°	5 POLE	PG11	60V AC/DC	4 AMPS	
	23837	FEMALE	STR	8 POLE	PG11	30V AC/DC	2 AMPS	
	23842	FEMALE	90°	8 POLE	PG11	30V AC/DC	2 AMPS	
DRAWINGS								
								
Temp. Range: -13° to 194° F (-25° to 90° C)								
Protection: IP67								

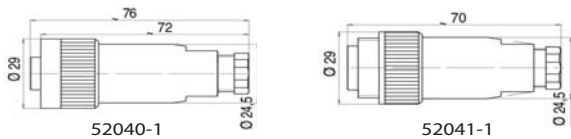
	BDI PART #	TYPE	STYLE	M12 TYPE	LENGTH	MAX VOLTAGE	MAX CURRENT	NOTES
M12 Connectors with Cable 	M124S02U34	FEMALE	STR	4 POLE	2 METERS	250V AC/DC	4 AMPS	UN SHIELDED
	M124S05U34	FEMALE	STR	4 POLE	5 METERS	250V AC/DC	4 AMPS	UN SHIELDED
	M124S10U34	FEMALE	STR	4 POLE	10 METERS	250V AC/DC	4 AMPS	UN SHIELDED
	76928-2833	FEMALE	90°	3 POLE	10 METERS	300VDC	4 AMPS	UN SHIELDED
	769282813	FEMALE	STR	3 POLE	2 METERS	250V AC/DC	4 AMPS	UN SHIELDED
	76928-2853	FEMALE	STR	3 POLE	5 METERS	250V AC/DC	4 AMPS	UN SHIELDED
	76928-2863	FEMALE	STR	3 POLE	10 METERS	250V AC/DC	4 AMPS	UN SHIELDED
	M125A03U75	FEMALE	90°	5 POLE	3 METERS	60V AC/DC	4 AMPS	UN SHIELDED
	M125S03U75	FEMALE	STR	5 POLE	3 METERS	60V AC/DC	4 AMPS	UN SHIELDED
	M128A03U25	FEMALE	90°	8 POLE	3 METERS	30V AC/DC	2 AMPS	UN SHIELDED
	M128S03U25	FEMALE	STR	8 POLE	3 METERS	30V AC/DC	2 AMPS	UN SHIELDED
	M128A10U25	FEMALE	90°	8 POLE	10 METERS	30V AC/DC	2 AMPS	UN SHIELDED
	M128S10S25	FEMALE	STR	8 POLE	10 METERS	30V AC/DC	2 AMPS	SHIELDED
DRAWINGS								
								
Temp. Range: -13° to 158° F (-25° to 70° C)								
Protection: IP69K								

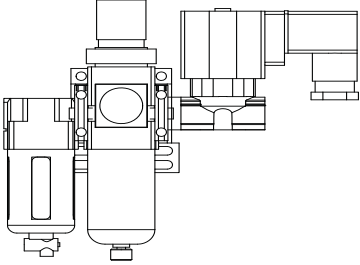
	BDI PART #	TYPE	STYLE	TYPE	CONNECTION	MAX VOLTAGE	MAX CURRENT	NOTES
Bayonet Conn. Field Attachable 	52040-1	FEMALE	STR	4 POLE	PG9	400V	12 AMPS	Max 6-9.5mm Cable Dia.
	52041-1	MALE	STR	4 POLE	PG9	400V	12 AMPS	Max 6-9.5mm Cable Dia.
DRAWINGS								
								
Temp. Range: -40° to 212° F (-40° to 100° C)								
Protection: IP67 IP65(for cable 6-7mm)								

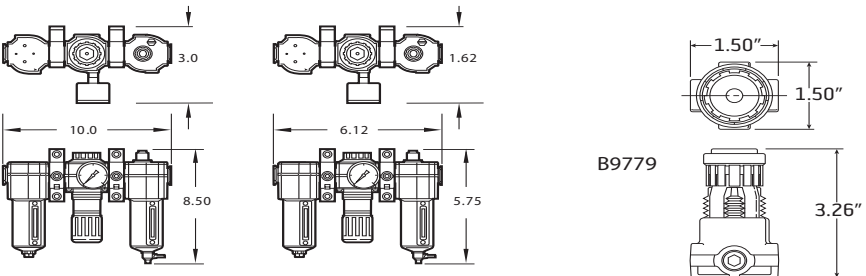
	BDI PART #	FILTER REGULATOR	COALESCING FILTER	SOLENOID VOLTAGE	CONNECTION THREADS	REPLACEMENT ELEMENTS FILTER REGULATOR	REPLACEMENT ELEMENTS COALESCING FILTER
Air Preparation:	60195-5	5 µm	0.01 µm	110VAC	1/4NPTF	60200	60201
	60195-7			24VDC			
	60195-9			220VAC			
	60193-5*			N/A			
DRAWINGS							
 <p>Temp. Range: 23° to 140° F (-5° to 60° C)</p> <p>Max psi: 145</p>						<p><i>*Individual -no solenoid</i></p> <p><i>Filter/Regulator P.N. 60193-5</i></p>	

	BDI FRL PART #	THREADS	TYPE	NOTES	
Air Preparation:	F995	1/4NPTF	MINI FILTER-REGULATOR-LUBRICATOR	MINI	
	F6282	1/4NPTF	FILTER-REGULATOR-LUBRICATOR		
	F984	3/8NPTF	FILTER-REGULATOR-LUBRICATOR		
	F985	1/2NPTF	FILTER-REGULATOR-LUBRICATOR		
	F986	3/4NPTF	FILTER-REGULATOR-LUBRICATOR		
	F955	1/4NPTF	MINI FILTER-REGULATOR	MINI	
	F956	1/4NPTF	FILTER-REGULATOR		
	F957	3/8NPTF	FILTER-REGULATOR		
	F958	1/2NPTF	FILTER-REGULATOR		
	F952	3/4NPTF	FILTER-REGULATOR		
	F993	1/4NPTF	MINI FILTER	MINI	
	F6022	1/4NPTF	FILTER	METAL BOWL & AUTO DRAIN	
	F975	3/8NPTF	FILTER	METAL BOWL & AUTO DRAIN	
	F6024MD	1/2NPTF	FILTER	METAL BOWL & AUTO DRAIN	
Regulators	F982	3/4NPTF	FILTER	METAL BOWL & AUTO DRAIN	
	F991	1/4NPTF	MINI REGULATOR	MINI	
	B9779	1/8NPTF	REGULATOR	KNOB	
	F1192G	1/4NPTF	REGULATOR	KNOB & GAUGE	
	F973	3/8NPTF	REGULATOR	KNOB & GAUGE	
	F1194G	1/2NPTF	REGULATOR	KNOB & GAUGE	
	F1196G	3/4NPTF	REGULATOR	KNOB & GAUGE	
	F992	1/4NPTF	MINI LUBRICATOR	MINI	
	F6062	1/4NPTF	LUBRICATOR	METAL BOWL	
	DRAWINGS				
	 <p>Temp. Range: 23° to 140° F (-5° to 60° C)</p> <p>Max psi: 145</p>				
	 <p>Temp. Range: -40° to 180° F (-40° to 82° C)</p> <p>B9779 32° to 150° F (0° to 65.6° C)</p>		<p>F984-F985-F986 F995 B9779</p>		
	 <p>Lubricators</p>				

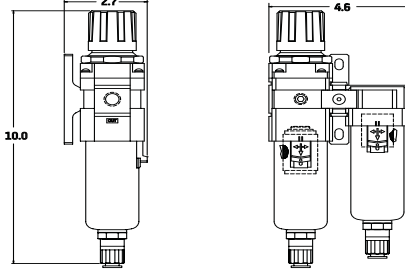
	BDI PART #	FILTER REGULATOR	COALESCING FILTER	NOTES	CONNECTION THREADS	REPLACEMENT ELEMENTS	
						FILTER REGULATOR	COALESCING FILTER
Air Preparation:	27159	5 µm	0.3 µm	REG ON LEFT	1/4NPTF	27161	27160
	27159-1			REG ON RIGHT			
Filter Regulator Coalescing Filter	DRAWINGS						
 <p>Temp. Range: 23° to 140° F (-5° to 60° C)</p> <p>Max psi: 145</p> <p>SCFM: 11.6</p>							

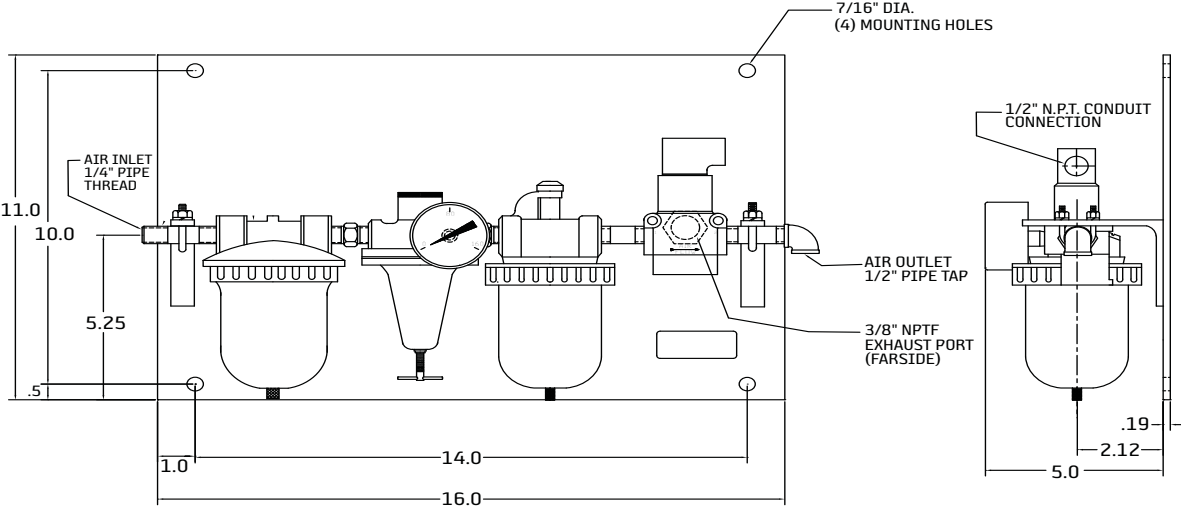
	BDI PART #	THREADS		VOLTAGE	SOLENOID CONNECTION	PANEL SIZE	NOTES
		INLET	OUTLET				
Air Preparation:	LD7767CA1	1/4NPT	1/2NPTF	120VAC	1/2NPTF	16" X 11"	F6282 + U10626A1
	LD7767CA2	1/4NPT	1/2NPTF	240VAC	1/2NPTF	16" X 11"	F6282 + U10626A2
	LD7767CA5	1/4NPT	1/2NPTF	24VDC	1/2NPTF	16" X 11"	F6282 + U10626A5
Air Control Panel Remote	DRAWINGS						
 <p>Temp. Range: -40° to 180° F (-40° to 82° C)</p>							

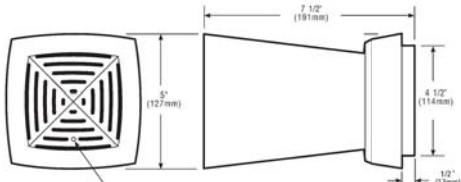
	BDI PART #	VOLTAGE 50/60 Hz	AMPS	COIL RESISTANCE	DECIBELS @ 10 FT'	REDUCED PRESSURE	NOTES
Horn	U914A1	120VAC	0.13	150 OHMS	103		
	DRAWINGS						
 <p>UL LISTED PLC COMPATIBLE NEMA 1</p>							

SLR Typical Compression Layout

	NAME	DESCRIPTION	EXAMPLE PART #	DETAIL PART PAGES
1	Tubing - Metal	5/32" O.D. TUBING	32196	Page 31
	Tubing - Nylon	5/32" O.D. nylon tubing	5N25-25	Page 30
	Hose Assemblies	hose assemblies with 5/32"(4mm) stand-pipe ends	85225-16	Page 22
2	Compression Bushings	5/32" male compression bushing	B1371	Page 18
3	Compression Nuts	5/32" female compression nut	B1095	
4	Compression Sleeves-Double side	5/32" sleeve for metal tubing	B1061	Page 19
5	Compression Sleeves-Single side	5/32" sleeve for plastic tubing	B8272	
6	Meter Units	Lube point mount meter unit for 5/32" tubing	B1083	Page 34-35
7		Junction mounted meter unit for 5/32" tubing	B2495	
8	Tubing Adapters Assemblies	5/32" tube X 1/8NPT male str. assembly	B3297	Page 10-11
9	Plugs	5/16-24 Plug	B3784	Page 20

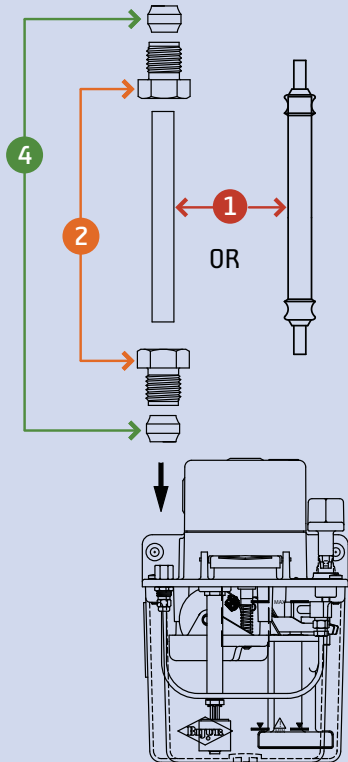
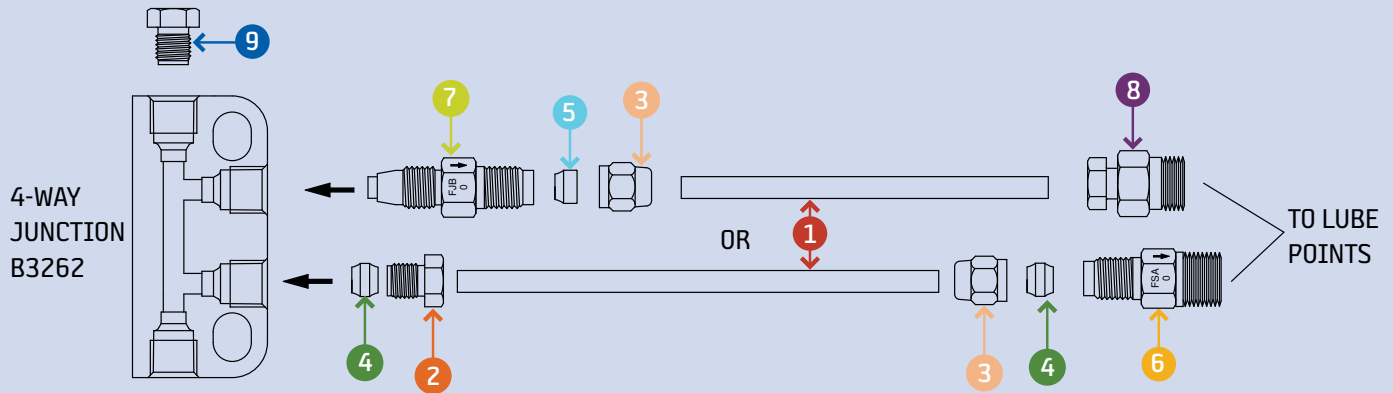

SLR Typical Continuous Layout

	NAME	DESCRIPTION	EXAMPLE PART #	DETAIL PART PAGES
1	Tubing - Metal	5/32" O.D. TUBING	32196	Page 31
	Tubing - Nylon	5/32" O.D. nylon tubing	5N25-25	Page 30
	Hose Assemblies	hose assemblies with 5/32"(4mm) stand-pipe ends	85225-16	Page 22
2	Compression Bushings	5/32" male compression bushing	81371	Page 18
3	Compression Nuts	5/32" female compression nut	81095	
4	Compression Sleeves-Double side	5/32" sleeve for metal tubing	81061	Page 19
5	Compression Sleeves-Single side	5/32" sleeve for plastic tubing	88272	
6	Control Units	Lube point mounted control unit for 5/32" tubing	87026	Page 36-37
7		Junction mount control unit for 5/32" tubing	87038	
8	Tubing Adapters Assemblies	5/32" tube X 1/8NPT str. assy	83297	Page 10-11
9	Plugs	5/16-24 Plug	83784	Page 20
10	Reducer Bushing	1/2NPT x 1/4NPTF	89953	Page 8
11	Tubing Adapter	1/4" Tube x 1/4NPT str assy	86533	Page 10-11
12	Tubing	1/4" Steel Tube	27721	Page 31

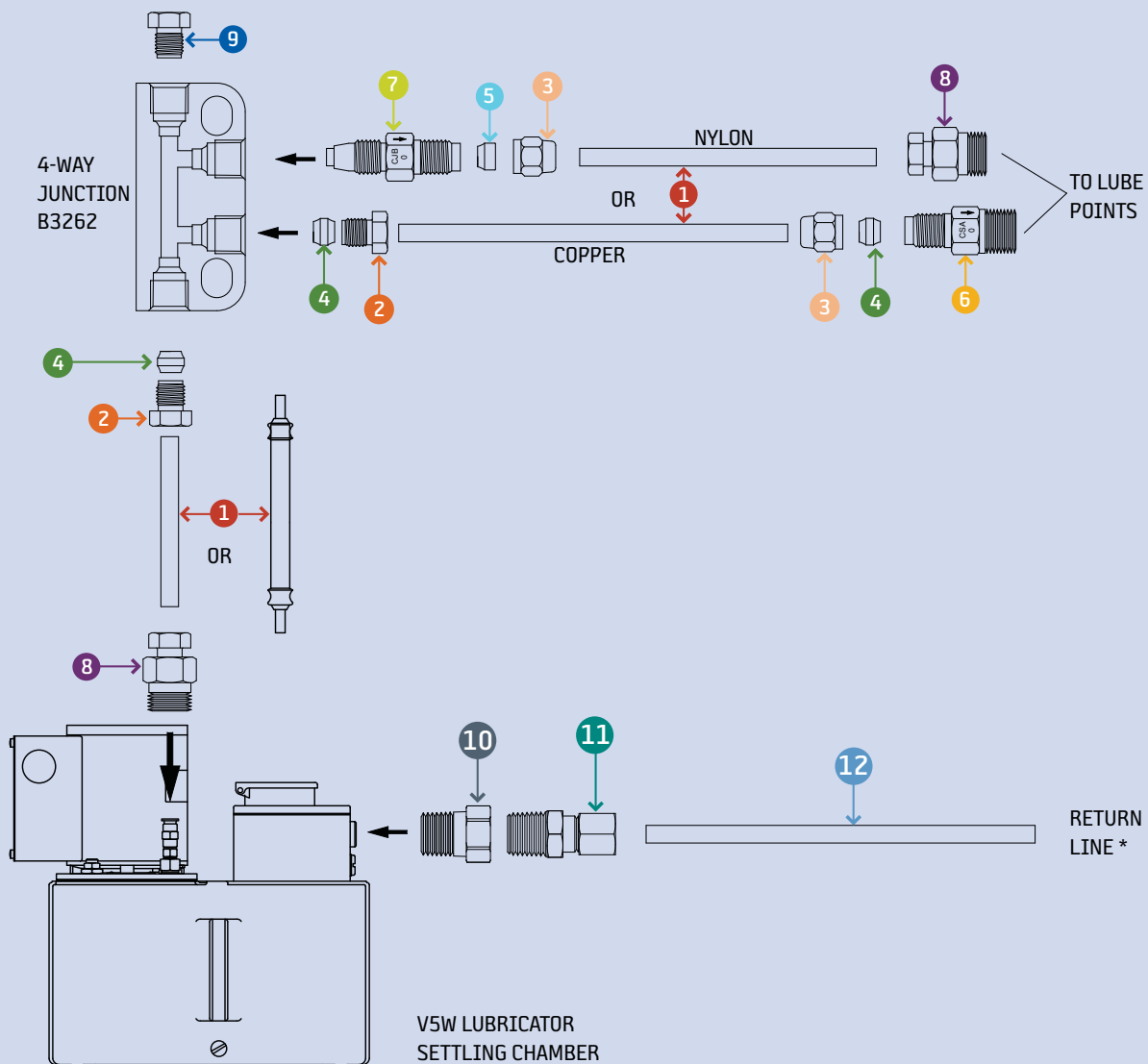

* Note: Return line filter recommended.

PDI Typical Air-Oil Layout

NAME	DESCRIPTION	EXAMPLE PART #	DETAIL PART PAGES
1	Supply Line Tubing - Nylon	6mm O.D. TUBING	810437C
	Hose Assemblies	PDI hose assy with 6mm stand-pipe ends	34971-10
2	Copper Washer	1/4BSPP copper washer	35010
3	Pump Outlet Fitting	6mm tube X 1/4BSPP	AR397
4	Tubing Adapters	6mm tube X 1/8NPT comp str	24361-1
		6mm tube X 1/8NPT 90 degree comp str	AR139
		5/16" tube x 1/4NPT comp str	15920-4
5	Tubing	5/32" (4mm) tube Poly-Clear	4N25W
6	Tube Adapters	Tubing adapter assemblies PTC	20101-1
7	Compression Bushing	5/32"(4mm) male bushing	B1371
8	Compression Sleeve	5/32"(4mm) sleeve	B8272

SUREFIRE II PDI LUBRICATOR

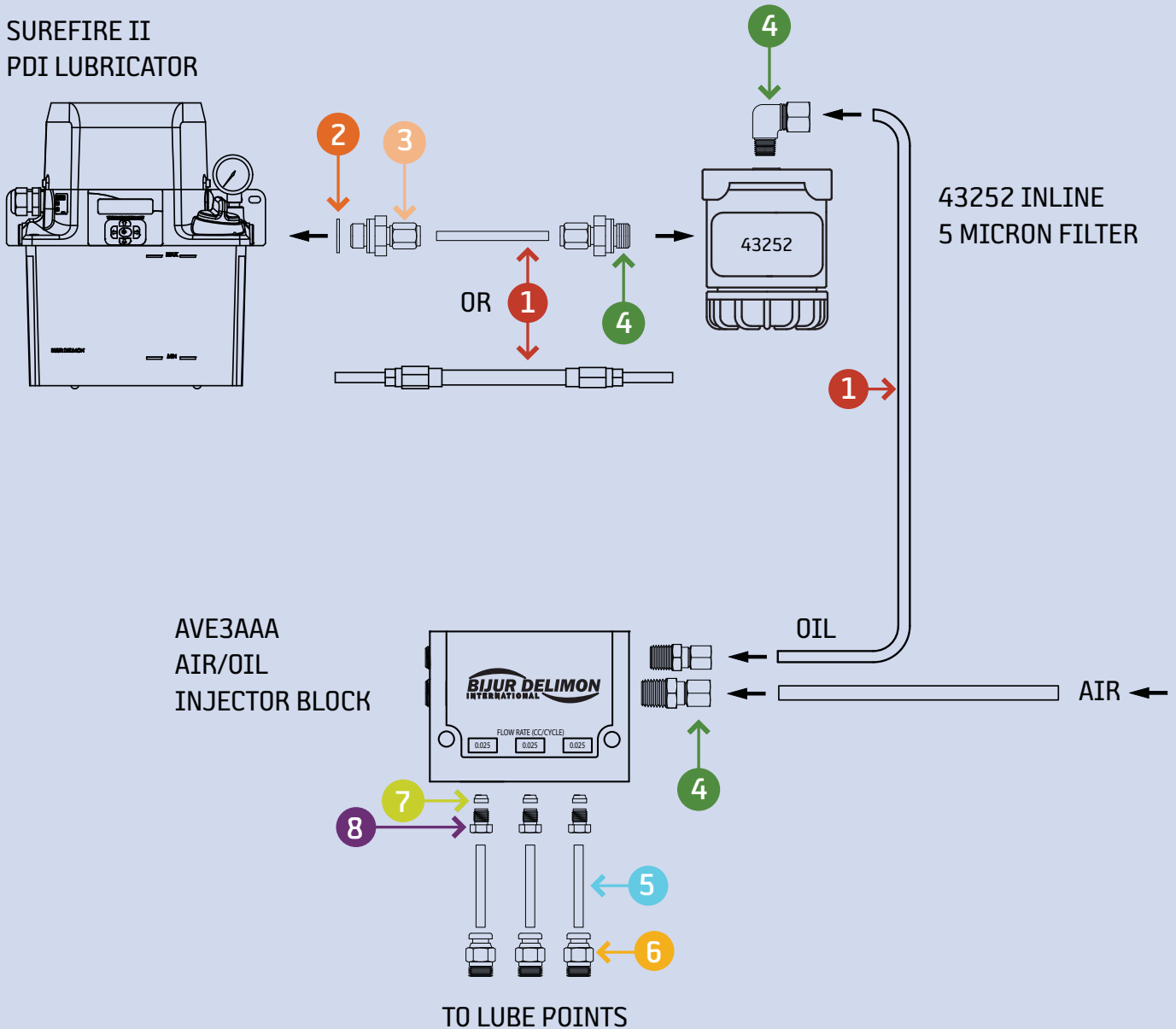

PDI ZEM Typical Layout

	NAME	DESCRIPTION	EXAMPLE PART #	DETAIL PART PAGES
1	Supply Line Tubing - Nylon	6mm O.D. TUBING	B10437C	Page 30
	Hose Assemblies	PDI hose assy with 6mm stand-pipe ends	34971-10	Page 23
2	Copper Washer	1/4BSPP copper washer	35010	Page 21
3	Pump outlet fitting	6mm tube X 1/4BSPP	AR397	Page 10
4	Str adpt tube fittings	6mm tube X M10X1 compression str	AR426	Page 10
5	Str adpt tube fittings PTC	6mm tube X M10X1 push to connect str	AR1855	Page 16
6	Copper washer	M10 copper washer	20913-1	Page 21
7	Plug	M10X1 plug	AR1024	Page 20
8	Feed Line Tubing - Copper	4mm (5/32") copper tubing	32196	Page 31
9	Lube point fittings	4mm (5/32") X 1/8NPT	B3297	Page 10
10	Feed Line Tubing - Nylon	4mm (5/32") nylon tubing	5N25-25	Page 30
11	Lube point fittings PTC	4mm (5/32") X 1/8NPT	B3297	Page 16
12	Compression Sleeve	4mm (5/32") sleeve (ferrile/olive)	35001	Page 18
13	Compression Bushing	4mm (5/32") male bushing	15326	Page 19

SUREFIRE II PDI LUBRICATOR

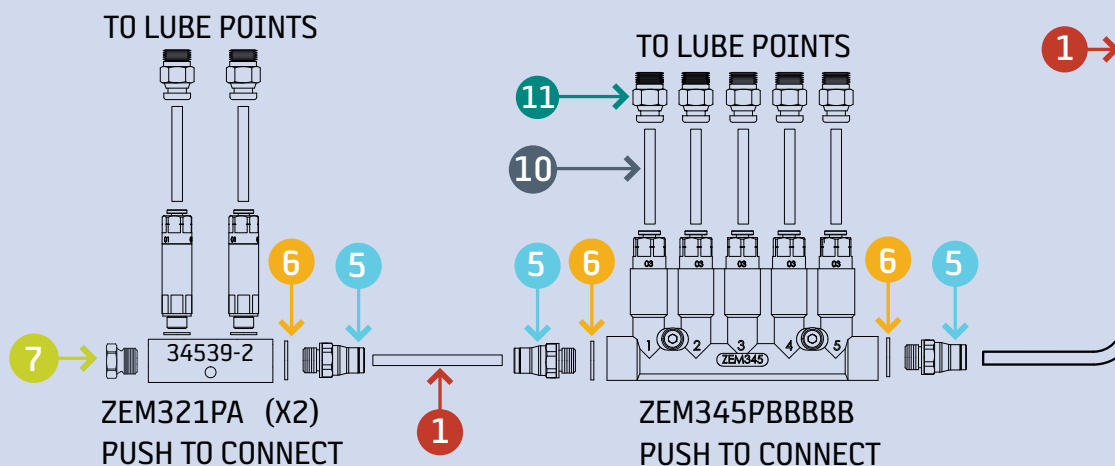
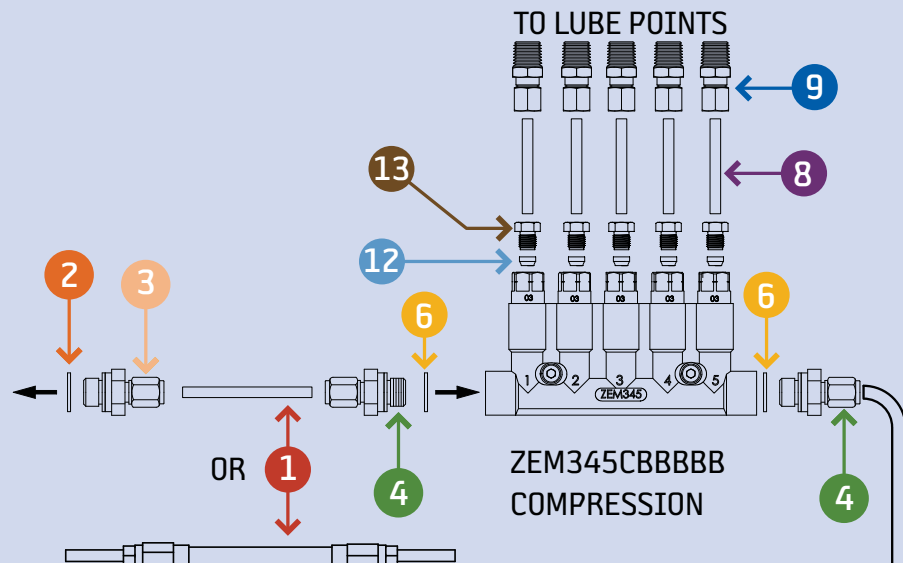
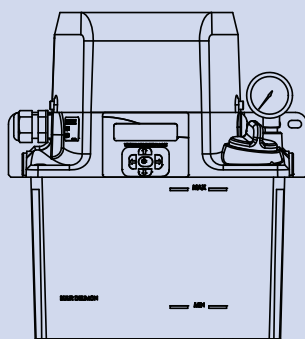

PDI FL-33/FL-42 & FL-32/FL-43 Typical Layout

	NAME	DESCRIPTION	EXAMPLE PART # FL33 - FL42 (1/8 NPT)	EXAMPLE PART # FL32 - FL43 (1/4 NPT)	DETAIL PART PAGES	
SUPPLY LINE	1	Hose*		U7184	Page 26	
						U7186
	2	Hose Ends	1/4" I.D. Hose X Female JIC Swivel 7/16-20		U43844	Page 26
	3	Hose Adapters	JIC 7/16-20 STR adapter	U43124	U43144	Page 27
			JIC 7/16-20 90 degree elbow	35528-5	35528-1	
			JIC 9/16-18 STR adapter	35575-1	U43146	
			JIC 9/16-18 90 degree adapter	35528-8	35528-2	
	4	Tubing adapters	1/4" OD Tube adapter straight	U83B1	U83B2	Page 10-11
			1/4" OD Tube adapter 90 degree	U83B1+U1104AS	B10092-1	
3/8" OD Tube adapter straight			U83D1	U83D2		
3/8" OD Tube adapter 90 degree			7962FBUS + U1104AS	U83D2+U1104B		
FEED LINES & LUBE POINT FTGS	5	Hose		27730	Page 26	
	6	Tubing Adapters	1/8" O.D. Nylon Tubing	27722	Page 30	
			1/8" O.D. Copper Tubing	4C30	Page 31	
	7	Manifold Plug	1/8" O.D. Tube X 1/4-28 STR adapter	27727	Page 10-11	
			1/8" O.D. Tube X 1/8NPT STR adapter	27726		
			1/8" O.D. Tube X 1/4-28 90 degree adapter	27728		
			1/8" O.D. Tube X 1/8NPT 90 degree adapter	27725		
		Plugs end of line	U119AC	U119BC	Page 20	

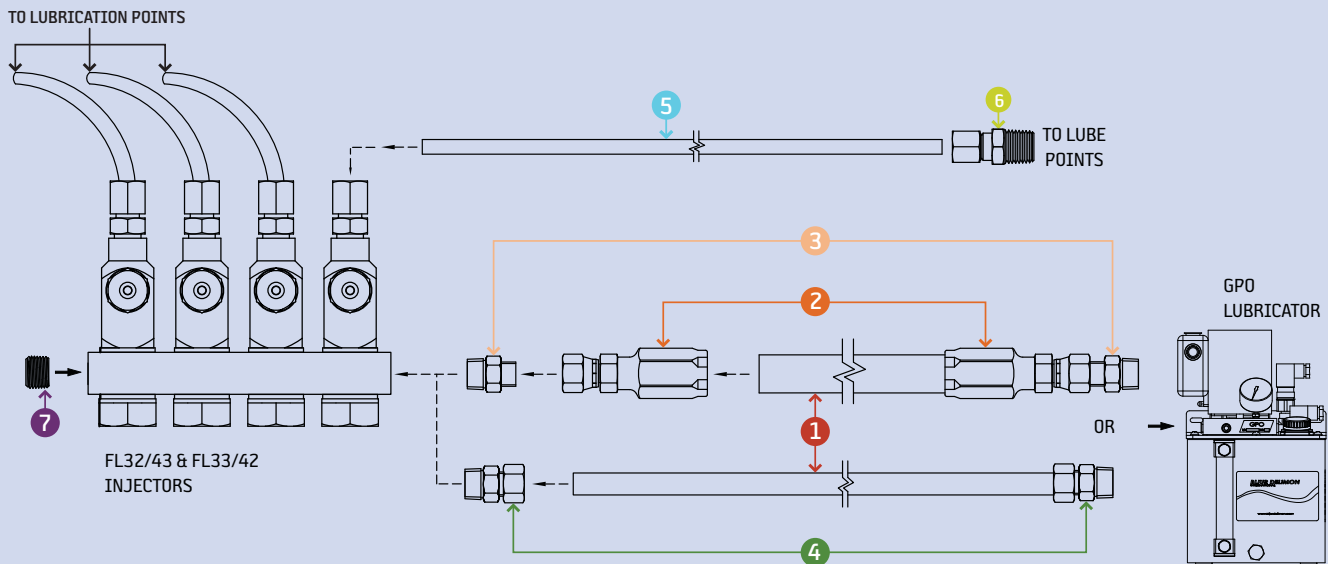

* Note: 3/8" O.D. tubing and 1/4" I.D. hose are to be used for NLGI #1 grease or lighter and a maximum supply line length of 25 feet. If a supply line of longer than 25 feet is needed or NLGI #2 grease is to be used consult factory for proper supply line size.

PDI FL-11 / FL-45 Typical Layout

	NAME	DESCRIPTION	EXAMPLE PART #	DETAIL PART PAGES		
FEED LINES & LUBE POINTS	1	Hose	5/32"(4mm) I.D. flexible hose	34962-25	Page 23	
		Hose	1/4" I.D. hose	HOS12125-50		
	2	Tubing	1/4" O.D. nylon tubing x .050 wall	70420-25	Page 30	
			1/4" O.D. steel	U424E4	Page 31	
	3	Hose Ends	5/32" I.D.(4mm) hose coupling x 1/4" stand pipe	29117	Page 26	
			1/4" I.D. hose x female JIC swivel 7/16-20	85493		
			JIC 7/16-20 x 1/4" NPT, straight adapter	U43144		
			JIC 7/16-20 x 1/4" NPT, 90° elbow adapter	35528-1		
	4	Tubing Adapters	JIC 7/16-20 x 1/8" NPT, straight adapter	U43124	Page 27	
			JIC 7/16-20 x 1/8" NPT, 90° elbow adapter	35528-5		
			1/4" O.D. tube x 1/4NPT, straight tubing adapter	U83B2		Page 10-11
			1/4" O.D. tube x 1/4NPT, 90° elbow tubing adapter	B10092-1		
3/8" O.D. tube x 1/4NPT, straight tubing adapter	U83D2					
3/8" O.D. tube x 1/4NPT, 90° elbow tubing adapter	U83D2+U1104B					

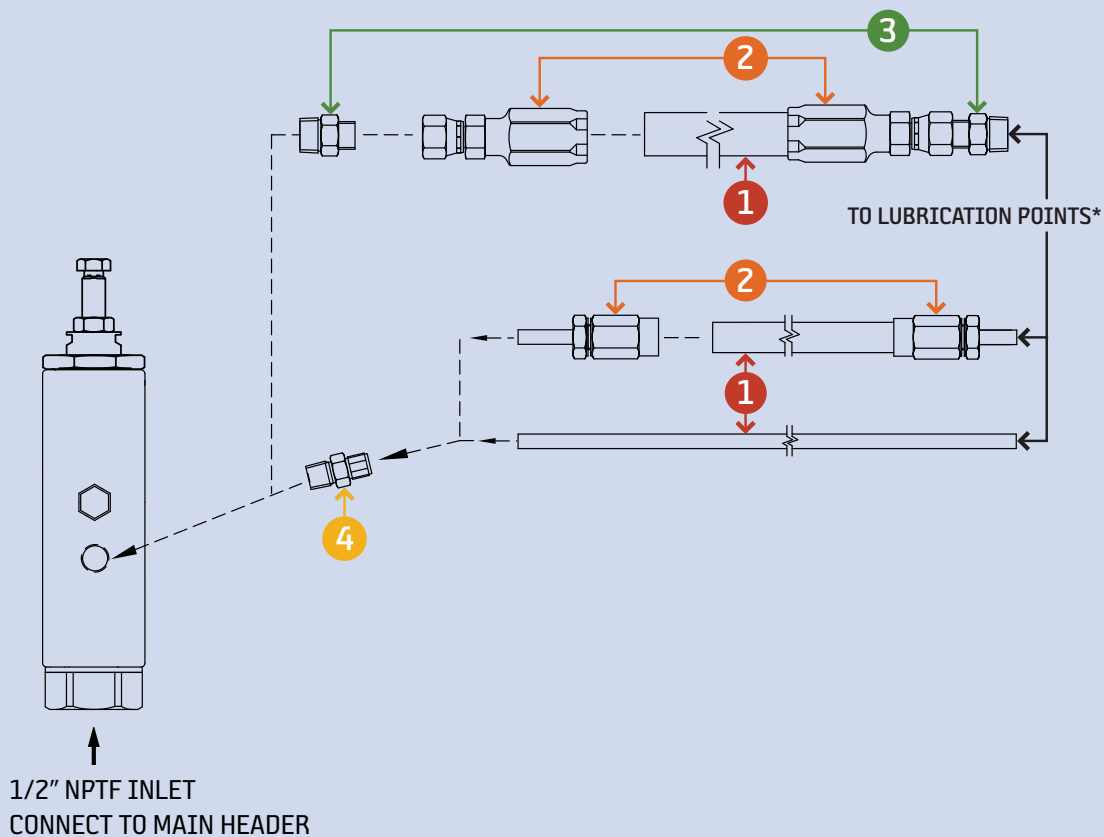

PDI FL1 / FL-44 Typical Layout

	NAME	DESCRIPTION	EXAMPLE PART #	DETAIL PART PAGES		
SUPPLY LINE	1	Hose*	1/4" I.D. hose (SAE 100R2) 5800 psi wp	U7184	Page 26	
				3/8" I.D. hose (SAE 100R2) 4750 psi wp		U7186
	2	Tubing*	1/4" O.D. steel	U424E4	Page 31	
			3/8" O.D. steel tubing	U424E6		
	3	Hose Adapters	1/4" I.D. hose x female JIC swivel 7/16-20	U43844	Page 26	
			3/8" I.D. hose x female JIC swivel 9/16-18	U43866		
			JIC ADAPTERS	JIC 7/16-20		JIC 9/16-18
			JIC x 1/4" NPT, straight adapter	U43144		U43146
			JIC x 3/8" NPT, straight adapter	35575		U43166
			JIC x 1/4" NPT, 90° elbow adapter	35528-1		35528-2
4	Tubing Adapters	JIC x 3/8" NPT, 90° elbow adapter	35528-3	35528-4	Page 10-11	
		NPT SIZES	1/4 NPT	3/8NPT		
		1/4" O.D. tube x NPT, straight tubing adapter	U83B2	U83B3		
		1/4" O.D. tube x NPT, 90° elbow tubing adapter	B10092-1	U83B3+U1104C		
		3/8" O.D. tube x NPT, straight tubing adapter	U83D2	U83D3		
		3/8" O.D. tube x NPT, 90° elbow tubing adapter	B10092-4	B10092-5		
FEED LINES & LUBE POINTS	5	Hose	5/32"(4mm) I.D. flexible hose	34962-25	Page 23	
			1/4" I.D. hose	HOS12125-50		Page 26
	6	Hose Ends	1/4" O.D. nylon tubing x .050 wall	70420-25	Page 30	
			5/32" I.D.(4mm) hose coupling x 1/4" stand pipe	29117	Page 23	
	7	Tubing Adapters	1/4" I.D. hose x female JIC swivel 7/16-20	85493	Page 26	
			1/4" O.D. tube x 1/8" NPT, straight tubing adapter	U83B1	Page 10-11	
	8	Hose Adapters	1/4" O.D. tube x 1/8" NPT, 90° tubing adapter	U83B1+U1104AS		
			JIC 7/16-20 x 1/8" NPT, straight adapter	U43124	Page 27	
	JIC 7/16-20 x 1/8" NPT, 90° elbow adapter	35528-5				

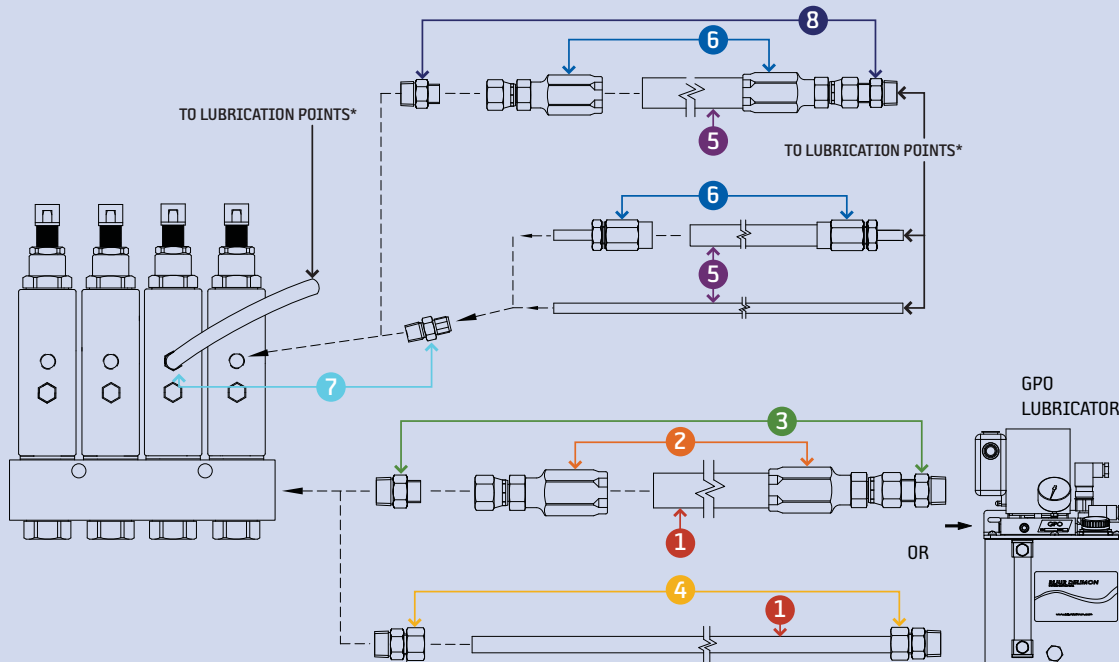

* Note: 3/8" O.D. tubing and 1/4" I.D. hose are to be used for NLGI #1 grease or lighter and a maximum supply line length of 25 feet. If a supply line of longer than 25 feet is needed or NLGI #2 grease is to be used consult factory for proper supply line size.

Progressive 3000 Typical Layout

	NAME	DESCRIPTION	EXAMPLE PART #	DETAIL PART PAGES
SUPPLY LINE	1 Tubing Steel	3/8" O.D. Steel Tubing	U424E6	Page 31
		1/2" O.D. Steel Tubing	U424E8	
	2 Tubing Adapters	3/8" O.D. Tube X 3/8"NPT straight adapter	U83D3	Page 10-11
		1/2" O.D. Tube X 3/8"NPT straight adapter	U53EM3	
		3/8" O.D. Tube X 3/8"NPT 90 degree adapter	B10092-5	
FEED LINE & LUBE POINT FTGS	3 Tubing	1/4" O.D. Steel Tubing	U424E4	Page 31
		3/8" O.D. Steel Tubing	U424E6	
	4 Tubing Adapters	1/4" O.D. Tube X 1/4"NPT straight adapter	U83B2	Page 10-11
		3/8" O.D. Tube X 1/4"NPT straight adapter	U83D2	
		1/4" O.D. Tube X 1/4"NPT 90 degree adapter	B10092-1	
	5 Plugs	1/4"NPT	U119BC	Page 20
6 Tubing Adapter	1/4" O.D. Tube X 1/8"NPT straight adapter	U83B1	Page 10-11	
	3/8" O.D. Tube X 1/8"NPT straight adapter	7962FBUS		

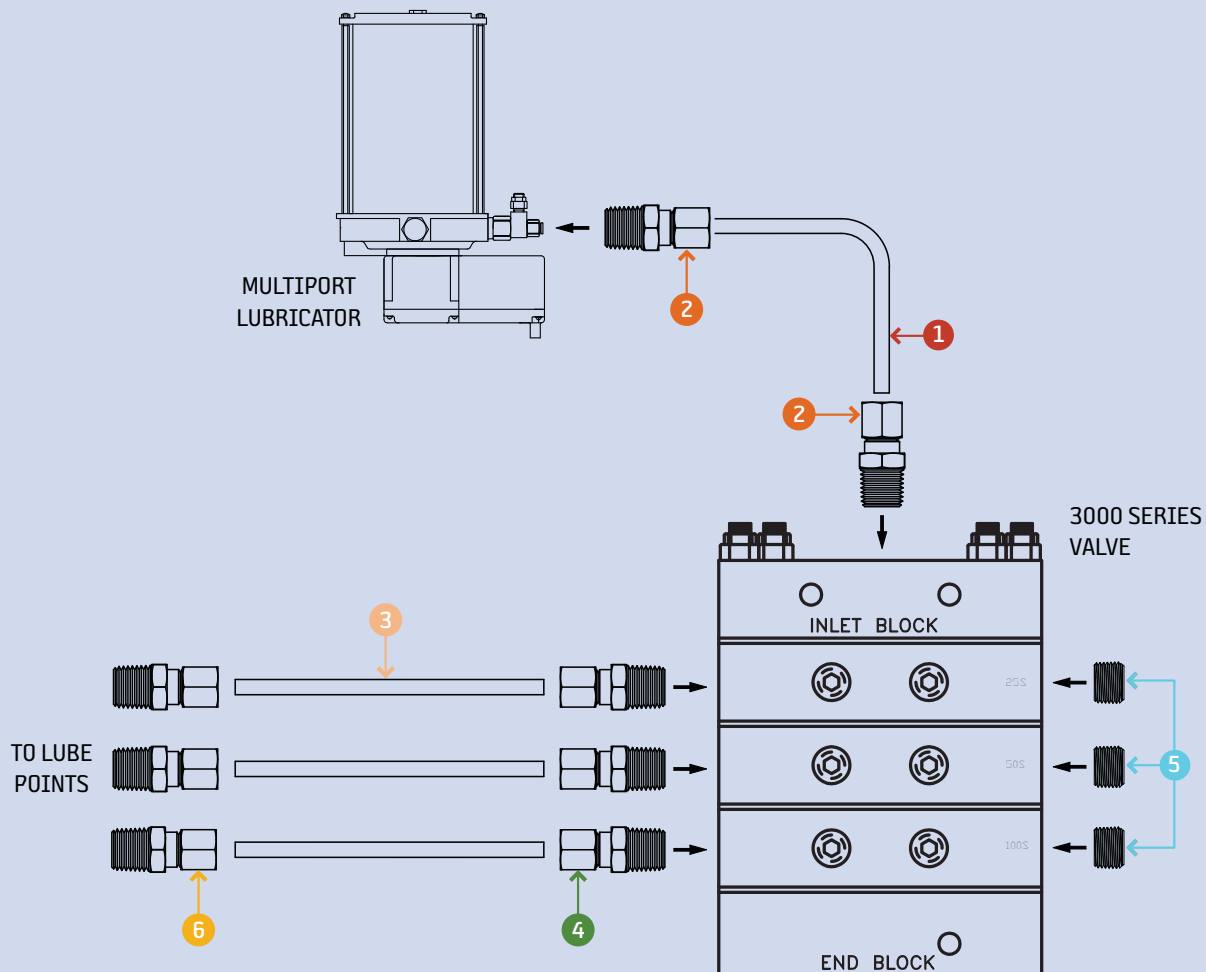

* Note: 1/4" O.D. tubing is to be used with oil or grease runs of 10 feet or less. 3/8" O.D. tubing is to be used for NLGI #2 grease or lighter and if used to supply a secondary valve. If a supply line of longer than 25 feet is needed consult factory for proper supply line size.

Progressive M2500G Typical Layout

	NAME	DESCRIPTION	EXAMPLE PART #	DETAIL PART PAGES
SUPPLY LINE	1	Tubing*	1/4" O.D. Steel Tubing U424E4	Page 31
			3/8" O.D. Steel Tubing U424E6	
	2	Tubing Adapters	1/4" O.D. Tube X 1/4"NPT straight adapter U83B2	Page 10-11
			3/8" O.D. Tube X 1/4"NPT straight adapter U83D2	
			1/4" O.D. Tube X 1/4"NPT 90 degree adapter B10092-1	
FEED LINE & LUBE POINT FTGS	3	Tubing	1/4" O.D. Steel Tubing U424E4	Page 31
			1/4" O.D. Nylon Tubing 70420-25	Page 30
	4	Tubing Adapters	1/4" O.D. Tube X 1/8"NPT straight adapter U83B1	Page 10-11
			1/4" O.D. Tube X 1/8"NPT straight adapter B6534	
			1/4" O.D. Tube X 1/8"NPT 90 degree adapter U83B1+U1104AS	
			1/4" O.D. Tube X 1/8"NPT 90 degree adapter B6536	
	5	Plugs	1/8"NPT U119AC	Page 20

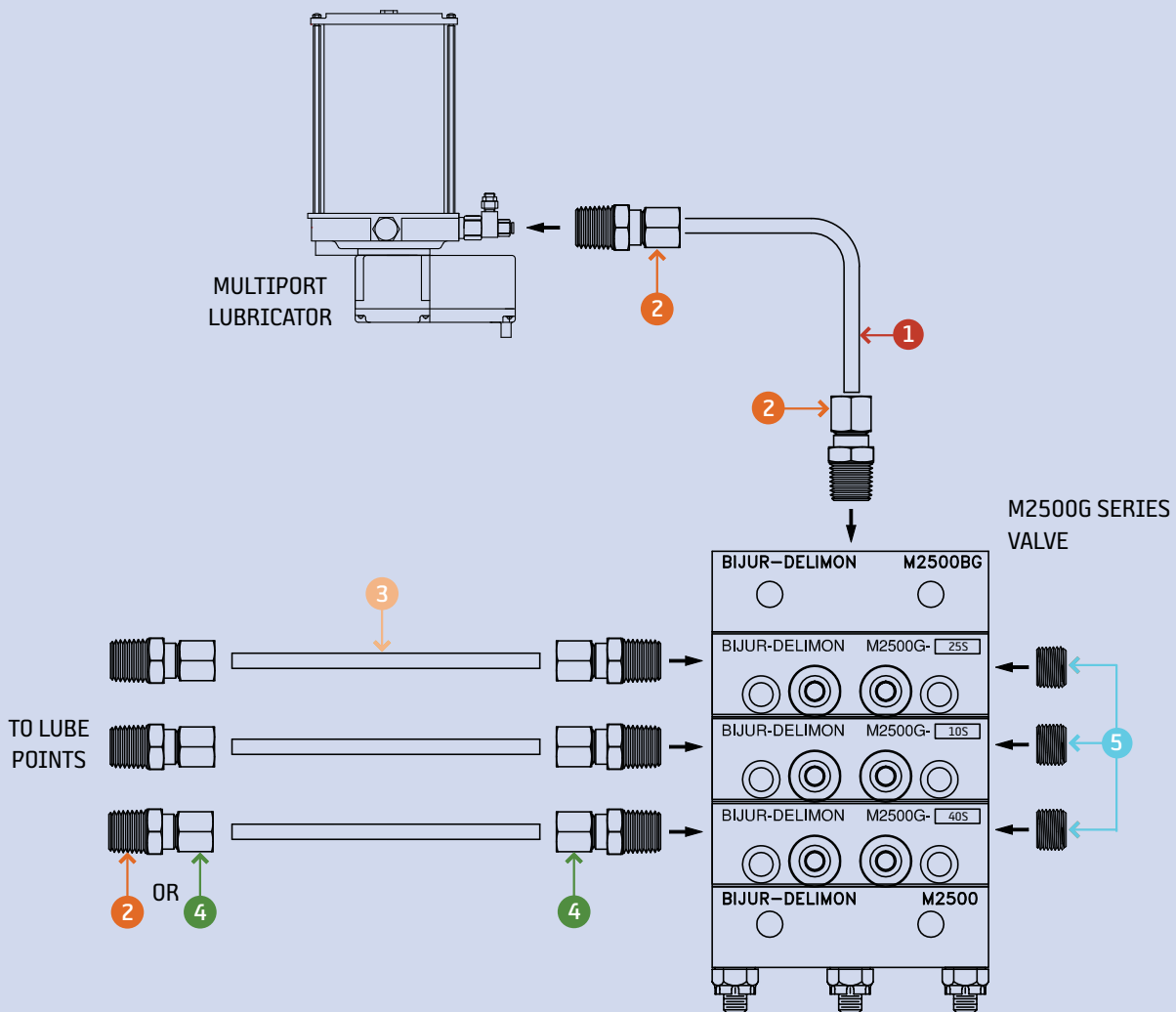

* Note: 1/4" O.D. tubing is to be used with oil only and 3/8" O.D. tubing is to be used for NLGI #2 grease or lighter. If a supply line of longer than 25 feet is needed consult factory for proper supply line size.

Progressive PVB/PVBM Typical Layout

	NAME	DESCRIPTION	EXAMPLE PART #	DETAIL PART PAGES	
SUPPLY LINE	1	Hose	1/4" I.D. hose (SAE 100R2) 5800psi wp	U7184	
			3/8" I.D. hose (SAE 100R2) 4750psi wp	U7186	Page 26
	2	Hose Ends	1/4" I.D. hose x female JIC swivel 7/16-20	U43844	
			3/8" I.D. hose x female JIC swivel 9/16-18	U43866	Page 26
FEED LINE & LUBE POINT FTGS	3	Hose Adapters	JIC SIZES	7/16-20 9/16-18	
			JIC x 1/4"NPT straight adapter	U43144 U43146	
			JIC x 1/4"NPT 90° elbow tubing adapter	35528-1 35528-2	
			JIC x 1/8"NPT straight tubing adapter	U43124 35575-1	
	4	Tubing Adapters	NPT SIZES	1/8NPT 1/4NPT	
			1/4" O.D. tube x NPT, straight tubing adapter	U83B1 U83B2	
			1/4" O.D. tube x NPT, 90° elbow tubing adapter	U83B1+ U1104AS B10092-1	
	5	Manual Override Fitting	1/8" NPT grease fitting, straight	F674	Page 28
	6	Tee	1/8" NPT(M) x 1/8"NPT(F) x 1/8" NPT(F) male run tee	26978	Page 7
	7	Hose	5/32"(4mm) I.D. flexible hose	34962	Page 23
			1/4" O.D. nylon tubing x .050 wall	70420-25	Page 30
	8	Hose Ends	5/32"(4mm) I.D. hose coupling x 1/4" stand pipe	29117	Page 23
	9	PVB Outlet Fittings	1/4" O.D. TBG outlet fitting with check valve	35166	
10	Outlet Plug "B"	Closure plug - "b" porting (singling)	74161-1851		
11	Clamping Ring "B"	Clamping ring - Required for "b" porting (singling)	23292	Page 38	
12	Outlet Plug "C"	Closure plug - "c" porting	74161-5741		
13	Copper Seal "C"	Copper seal - Required for "c" porting	72712-1094		

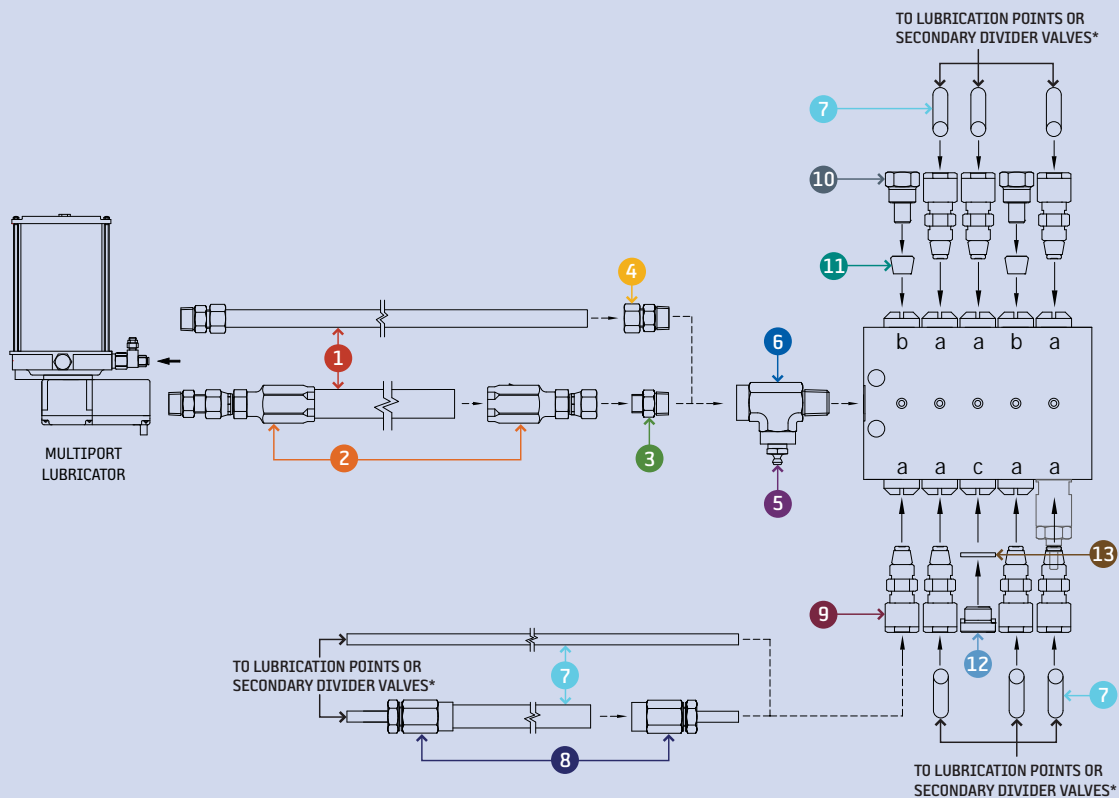

Progressive U-BLOCK Typical Layout

	NAME	DESCRIPTION	EXAMPLE PART #	DETAIL PART PAGES
SUPPLY	1 Tubing	1/4" O.D. Steel	U424E4	Page 31
	2 Tubing Connectors	1/4"BSPT x 1/4" Tube	20806	Page 10-11
FEED LINE	3 Tubing Connectors	1/8"BSPT X 1/4" Tube	15578	Page 10-11
	4 Tubing	1/4" O.D. Nylon	70420-25	Page 30
	5 Tubing Connectors	1/8"NPT X 1/4" Tube	B6534	Page 10-11

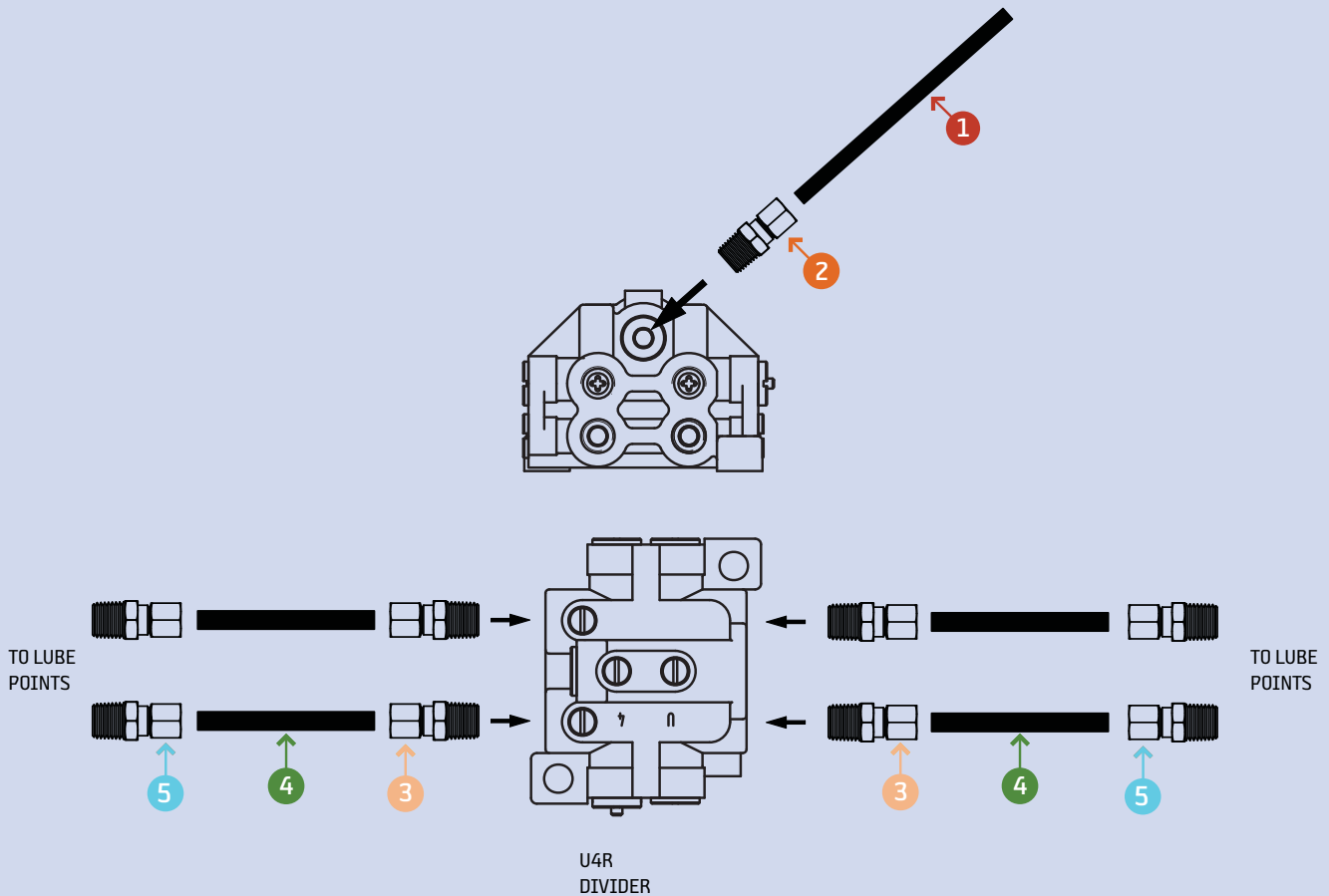

* Note: U-Block outlets cannot use standard plugs, use crossport kits.

Dualine DD/DM Typical Layout

	NAME	DESCRIPTION	EXAMPLE PART # DD20	EXAMPLE PART # DM30	EXAMPLE PART # DD50 DM40/50/60	DETAIL PART PAGES
SUPPLY LINE	1 Tubing	Steel Tubing 1/4" O.D.	U424E4	-	-	Page 31
		Steel tubing 3/8" O.D.	-	U424E6	U424E6	
2	Tubing Connectors	One piece nut & sleeve 1/4" tube	U81B1	-	-	Page 18
		One piece nut & sleeve 3/8" tube	-	U81D3	U81D3	
3	Tubing Connectors	One piece nut & sleeve 3/16" tube	U81AA1	-	-	Page 18
		One piece nut & sleeve 1/4" tube	-	U81B1	U81B2	
4	Tubing	3/16" O.D. tubing	U424C3-50	-	-	Page 31
		1/4" O.D. tubing	-	U424E4	U424E4	
5	Plugs	1/4"NPT	U119AC	-	-	Page 20
		3/8"NPT	-	U119CC	U119CC	
6	Tubing Adapter	3/16" O.D. Tube X 1/8"NPT str adapter	U83A1	-	-	Page 10
		1/4" O.D. Tube X 1/8"NPT str adapter	-	U83B1	U83B1	
7	Tubing Adapter	1/4" O.D. Tube X 1/8"NPT str adapter	-	U83B1	-	Page 10
		1/4" O.D. Tube X 1/4"NPT str adapter	-	U83B2	-	
		3/8" O.D. Tube X 1/8"NPT str adapter	-	7962FBUS	-	
		3/8" O.D. Tube X 1/4"NPT str adapter	-	U83D2	-	

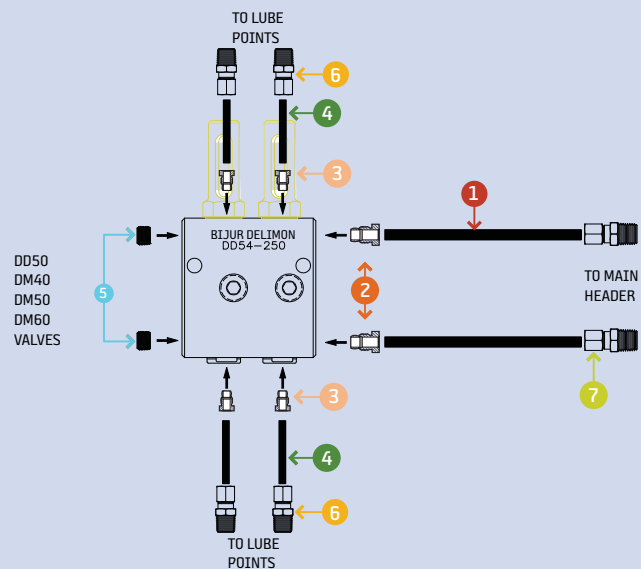
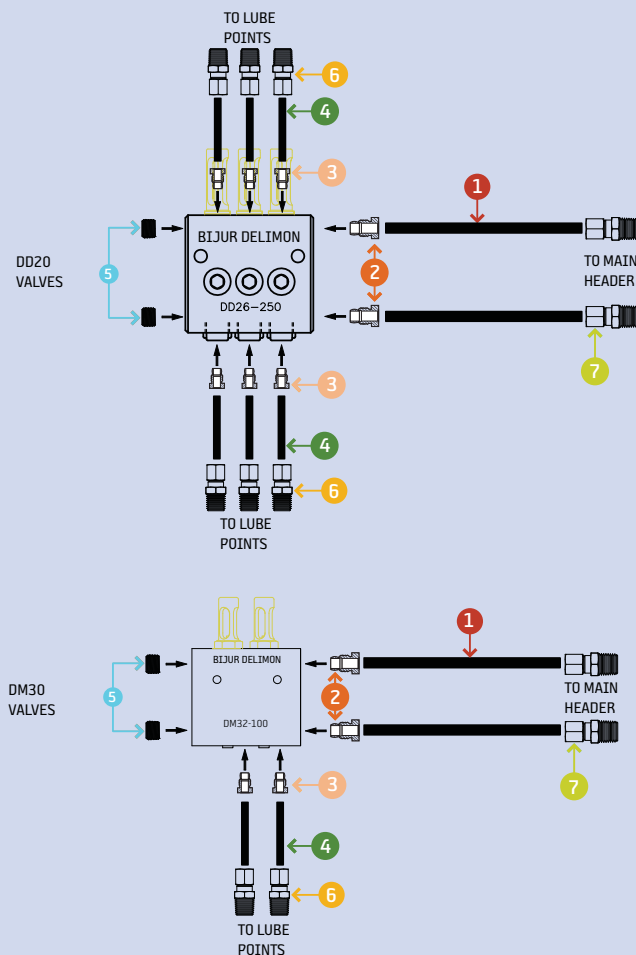

Innovators of engineered lubrication technology since 1872

Bijur Delimon International has ISO 9001:2015 and ISO 14001:2015 quality certified manufacturing facilities around the world, so your centralized lubrication system meets the highest industry quality standards. It's all part of our commitment to quality and customer service.



CORPORATE HEADQUARTERS (USA)

Bijur Delimon International
1 Copley Parkway.
Suite 104
Morrisville, NC 27560

(919) 465 4448 **TEL**
(800) 631 0168 **TOLL-FREE**
(919) 465 0516 **FAX**

GERMANY

Bijur Delimon International
Arminstrasse 15
40227 Düsseldorf

(+49) 211 / 77 74-0 **TEL**
(+49) 211 / 77 74-210 **FAX**

CHINA

Nanjing Bijur Machinery Products, Ltd.
#9 Hengtong Road
Nanjing Xingang Economic & Technical
Development Zone
Nanjing 210038

(+86) 25-85801188 **TEL**
(+86) 25-85802288 **FAX**

UNITED KINGDOM

Denco Lubrication Limited
Ramsden Court
Ramsden Road Rotherwas
Industrial Estate
Hereford, HR2 6LR

(+44) (0) 1432365000 **TEL**
(+44) (0) 1432365001 **FAX**

IRELAND

Bijur Lubricating Ireland Limited
Gort Road
Ennis, County Clare

(+353) 6568-21543 **TEL**
(+353) 6568-29667 **FAX**

FRANCE

Bijur Products, Inc.
PB 50 - 9 Avenue du Quebec
ZI de Courtabœuf Villebon
Sur Yvette F-91942
Courtaboeuf Cedex

(+33) (0)169298585 **TEL**
(+33) (0)169077627 **FAX**

SPAIN

Lubricacion Centralizada de Limon S.A.
Avenida Txori Erri 38
48150 Sondica Vicaya

(+34) 94-453-2000 **TEL**
(+34) 94-453-2500 **FAX**

INDIA

Bijur Delimon India Private Limited
Gat No. 448/13, Village Nigoje
Behind Mahindra Plant - Gate No. 8A
Taluka-Rajgurunagar (Khed) District-Pune,
Pin: 410 501 Maharashtra

(+91) 2032319149 **TEL**
(+91) 2027451725 **FAX**