



Farval®









The cover features a large, light-colored circular graphic on the left side, composed of many thin, overlapping lines that create a sense of depth and movement. This graphic overlaps with a background image of a yellow excavator and a yellow truck at a construction site. The text is positioned on the right side of the cover, with the Farval logo at the top and the title 'MOBILE ACCESSORIES GUIDE' in large, bold, blue letters. Below the title is a short paragraph in a smaller blue font. The overall design is clean and professional, with a focus on industrial equipment and accessories.

MOBILE ACCESSORIES GUIDE

Find accessories for our mobile lubrication systems using this comprehensive guide.

CXL2 Injectors & Manifolds

	NAME	DESCRIPTION	PART #	NOTES	
SUPPLY LINE	1 	1/4" I.D. Hose (SAE 100R2)	U7184	5800 psi (Working Pressure)	
		3/8" I.D. Hose (SAE 100R2)	U7186	4750 psi (Working Pressure)	
		1/2" I.D. Hose (SAE 100R2)	U7188	4000 psi (Working Pressure)	
	Tubing 	3/8" O.D. Stainless Steel Tubing	7938049304WSS	20' Lengths	
		3/8" O.D. Steel Tubing	U424E6	20' Lengths	
	2 	1/4" I.D. Hose x Female JIC Swivel 7/16-20	U43844	Steel	
		3/8" I.D. Hose x Female JIC Swivel 9/16-18	U43866	Steel	
		1/2" I.D. Hose x Female JIC Swivel 3/4-16	U43888	Steel	
	3 	JIC 7/16-20 x 1/4" NPT, Straight Adapter	U43144	Steel	
		JIC 7/16-20 x 1/4" NPT, 90° Elbow Adapter	35528-1	Steel	
		JIC 9/16-18 x 1/4" NPT, Straight Adapter	U43146	Steel	
		JIC 9/16-18 x 1/4" NPT, 90° Elbow Adapter	35528-2	Steel	
		JIC 3/4-16 x 1/4" NPT, 90° Elbow Adapter	35528-6	Steel	
		JIC 3/4-16 x 3/8" NPT, 90° Elbow Adapter	35528-7	Steel	
		JIC 7/16-20, Union Tee Adapter	35582-1	Steel	
		JIC 9/16-18, Union Tee Adapter	35582-2	Steel	
		JIC 3/4-16, Union Tee Adapter	35582-3	Steel	
		JIC 3/4-16 x 1/4" NPT, Straight Adapter	U43148	Steel	
	JIC 3/4-16 x 3/8" NPT, Straight Adapter	U43168	Steel		
4 Tubing Adapters	3/8" O.D. Tube x 1/4" NPT, Straight Adapter	U83D2	Steel		
	3/8" O.D. Tube x 1/4" NPT, 90° Elbow Adapter	U87D2	Steel		
	3/8" O.D. Tube Union	U84D	Steel		
FEED LINE	5 	5/32" I.D. Flexible Hose	34962-25 34962-164 34962-82-GFO 34962-164-GFO	For Hose End with Stand Pipe (GFO= NLGI #0 grease filled)	
		Tubing 	3/16" O.D. Nylon Tubing	B10271-4	Black (Bulk per Foot)
	3/16" O.D. Nylon Tubing, Grease Filled NLGI #0		35648	15' Lengths	
	(2) Tube x 3/16" O.D. Nylon Bundle, Grease Filled NLGI #0		35649	15' Lengths	
	(3) Tube x 3/16" O.D. Nylon Bundle, Grease Filled NLGI #0		35650	15' Lengths	
	3/16" O.D. Nylon Tubing, Grease Filled NLGI #0		35601	20' Lengths	
	(2) Tube x 3/16" O.D. Nylon Bundle, Grease Filled NLGI #0		35602	20' Lengths	
	(3) Tube x 3/16" O.D. Nylon Bundle, Grease Filled NLGI #0		35603	20' Lengths	
	1/4" O.D. Nylon Tubing x .062 Wall		70420-25	25' Length	
	1/4" O.D. Nylon Tubing x .062 Wall		70420-325	325' Roll	
	1/4" O.D. Nylon Tubing x .062 Wall, Grease Filled		35127	25' Lengths	
	6 Hose Ends		5/32" I.D. Hose Coupling x 3/16" Stand Pipe	29116	
			5/32" I.D. Hose Coupling x 1/4" Stand Pipe	29117	See Page 12 for Adapters
		5/32" I.D. Hose Coupling x 1/4" Stand Pipe 90°	29220	See Page 12 for Adapters	

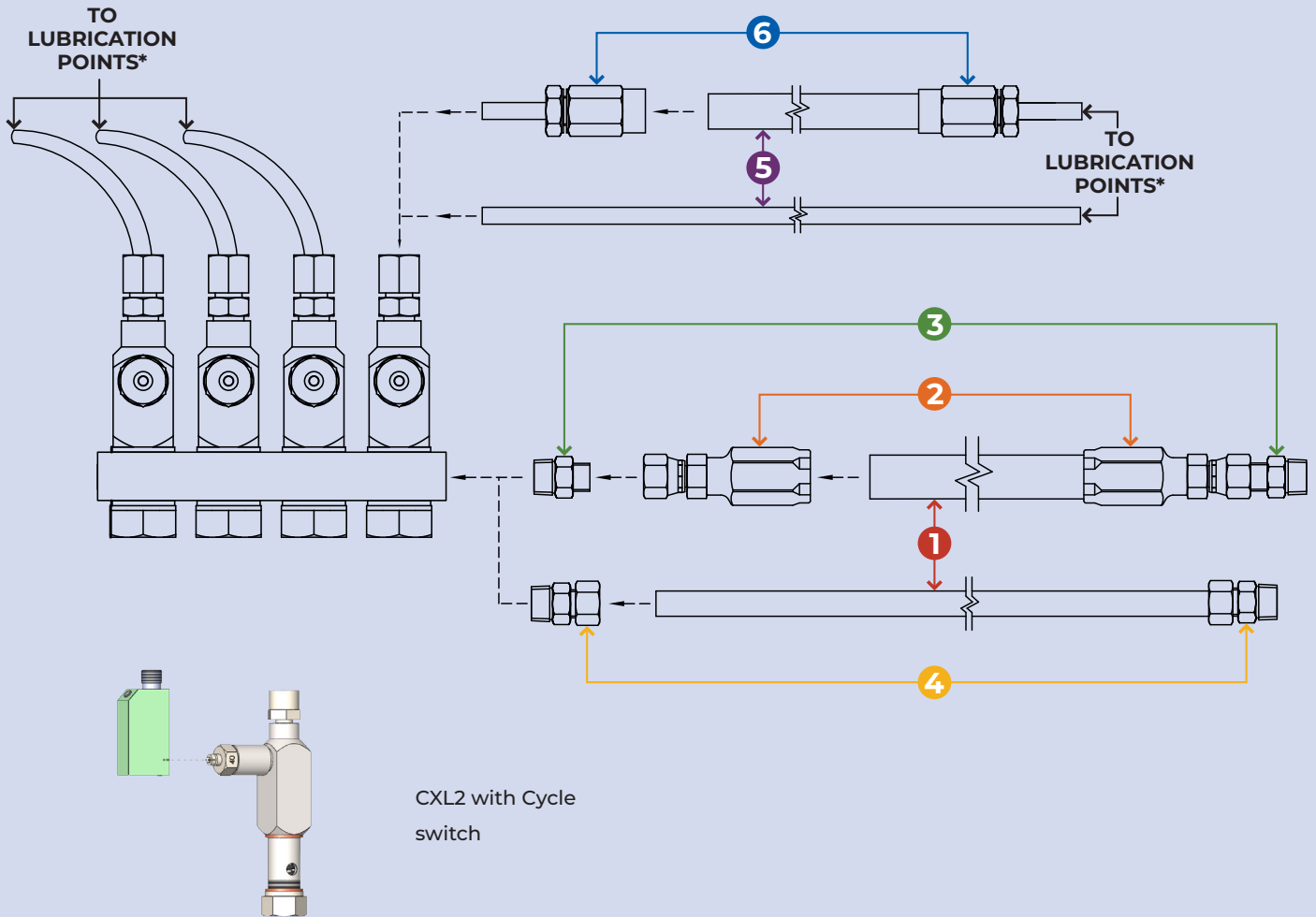







* See pages 12-15 for terminating fittings and miscellaneous components.
(3/16" tubing connections shown, 1/8" NPTF available on CXL2 outlets.)

NAME	DESCRIPTION	PART #	NOTES
ACCESSORIES	Cycle Switch 	66925S003*	* Use with cable part #76928-2863 or #76928-2833
	Proximity Cycle Switch with LED (PNP) (Use with pCo controller or customer PLC)	66925-1311*	* Use with cable part #76928-2863 or #76928-2833
	Cable, Straight, 10 Meters Long	76928-2863	
	Cable, 90°, 10 Meters Long	76928-2833	



NOTE: For additional information, see Datasheet #35482: CXL2 Datasheet

FL Injectors

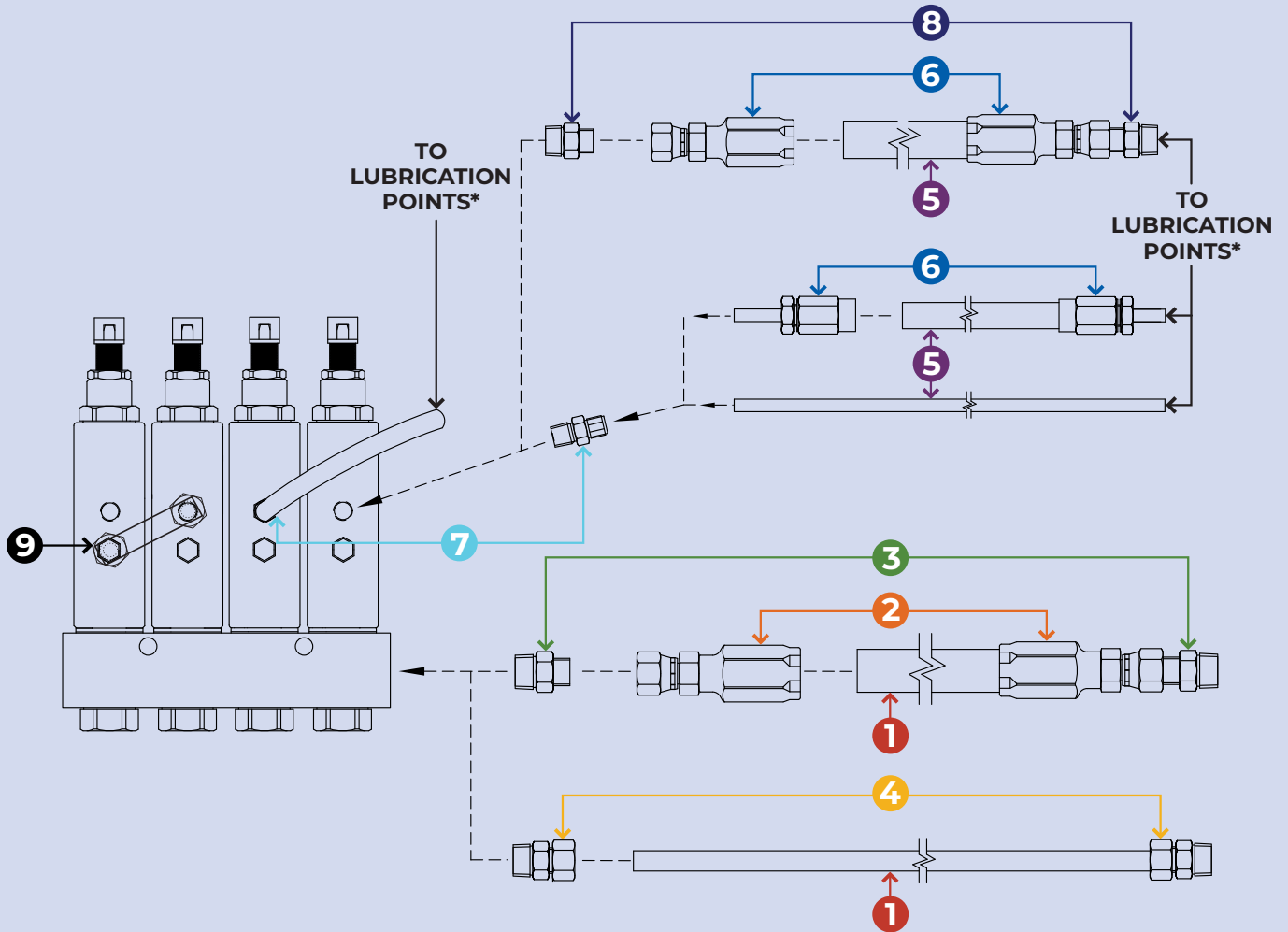
	NAME	DESCRIPTION	PART #	NOTES
SUPPLY LINE	1 	1/4" I.D. Hose (SAE 100R2)	U7184	5800 psi (Working Pressure)
		3/8" I.D. Hose (SAE 100R2)	U7186	4750 psi (Working Pressure)
		1/2" I.D. Hose (SAE 100R2)	U7188	4000 psi (Working Pressure)
	Tubing 	3/8" O.D. Stainless Steel Tubing	7938049304WSS	20' Lengths
		3/8" O.D. Steel Tubing	U424E6	20' Lengths
	2 	1/4" I.D. Hose x Female JIC Swivel 7/16-20	U43844	Steel
		3/8" I.D. Hose x Female JIC Swivel 9/16-18	U43866	Steel
		1/2" I.D. Hose x Female JIC Swivel 3/4-16	U43888	Steel
	3 	JIC 7/16-20 x 1/4" NPT, Straight Adapter	U43144	Steel
		JIC 7/16-20 x 3/8" NPT, Straight Adapter	35575	Steel
		JIC 7/16-20 x 1/4" NPT, 90° Elbow Adapter	35528-1	Steel
		JIC 7/16-20 x 3/8" NPT, 90° Elbow Adapter	35528-3	Steel
		JIC 3/4-16 x 1/4" NPT, 90° Elbow Adapter	35528-6	Steel
		JIC 3/4-16 x 3/8" NPT, 90° Elbow Adapter	35528-7	Steel
		JIC 9/16-18 x 1/4" NPT, Straight Adapter	U43146	Steel
		JIC 9/16-18 x 3/8" NPT, Straight Adapter	U43166	Steel
		JIC 9/16-18 x 1/4" NPT, 90° Elbow Adapter	35528-2	Steel
		JIC 9/16-18 x 3/8" NPT, 90° Elbow Adapter	35528-4	Steel
		JIC 7/16-20, Union Tee Adapter	35582-1	Steel
JIC 9/16-18, Union Tee Adapter		35582-2	Steel	
JIC 3/4-16, Union Tee Adapter		35582-3	Steel	
JIC 3/4-16 x 1/4" NPT, Straight Adapter		U43148	Steel	
JIC 3/4-16 x 3/8" NPT, Straight Adapter	U43168	Steel		
4 	1/4" O.D. Tube x 1/4" NPT, Straight Tubing Adapter	B10090-2	Steel	
	1/4" O.D. Tube x 3/8" NPT, Straight Tubing Adapter	U83B3	Steel	
	3/8" O.D. Tube x 3/8" NPT, Straight Tubing Adapter	U83D3	Steel	
	3/8" O.D. Tube x 1/4" NPT, Straight Tubing Adapter	U83D2	Steel	
	3/8" O.D. Tube x 1/4" NPT, 90° Elbow Tubing Adapter	U87D2	Steel	
	3/8" O.D. Tube x 3/8" NPT, 90° Elbow Tubing Adapter	U87D3	Steel	
	1/4" O.D. Tube x 3/8" NPT, 90° Elbow Tubing Adapter	U87B3	Steel	
	1/4" O.D. Tube x 1/4" NPT, 90° Elbow Tubing Adapter	B10092-1	Steel	
5 	5/32" I.D. Flexible Hose	34962-25 34962-164 34962-82-GF0 34962-164-GF0	For Hose End with Stand Pipe (GF0= NLGI #0 grease filled)	
	1/4" I.D. Hose	U7184	Use with Part #U43844	
	Tubing 	1/4" O.D. Nylon Tubing x .062 Wall	70420-25	25' Length
		1/4" O.D. Nylon Tubing x .062 Wall	70420-325	325' Roll
		1/4" O.D. Nylon Tubing x .062 Wall, Grease Filled	35127	25' Lengths











* See pages 12-15 for terminating fittings and miscellaneous components.

	NAME	DESCRIPTION	PART #	NOTES
6	Hose Ends 	5/32" I.D. Hose Coupling x 1/4" Stand Pipe	29117	
		5/32" I.D. Hose Coupling x 1/4" Stand Pipe 90°	29220	
		1/4" I.D. Hose x Female JIC Swivel 7/16-20	U43844	Steel; Use with U7184
7	Tubing Adapters 	1/4" O.D. Tube x 1/8" NPT, Straight Tubing Adapter	B10090-2	Steel
		1/4" O.D. Tube x 1/8" NPT, 90° Tubing Adapter	B10092-2	Steel
8	Hose Adapters	JIC 7/16-20 x 1/8" NPT, Straight Adapter	U43124	Steel
		JIC 7/16-20 x 1/8" NPT, 90° Elbow Adapter	35528-5	Steel
9	Injector Connector Bar	FL1 Connector Bar	13899	

NOTE: For additional information, see Datasheet #34254: FL1 Datasheet

PVBM Divider Valves

	NAME	DESCRIPTION	PART #	NOTES		
SUPPLY LINE	1		1/4" I.D. Hose (SAE 100R2)	U7184	5800 psi (Working Pressure)	
			3/8" I.D. Hose (SAE 100R2)	U7186	4750 psi (Working Pressure)	
			1/4" I.D. Hose (SAE100R7)	35546	3000 psi (Working Pressure)	
	Tubing		3/8" O.D. Stainless Steel Tubing	7938049304WSS	20' Lengths	
			3/8" O.D. Steel Tubing	U424E6	20' Lengths	
	2		1/4" I.D. Hose x Female JIC Swivel 7/16-20	U43844	Steel	
			3/8" I.D. Hose x Female JIC Swivel 9/16-18	U43866	Steel	
			1/4" I.D. Hose x Female JIC Swivel 7/16-20	201188	Steel; Use with Part #35546	
	3		JIC 7/16-20 x 1/4" NPT, Straight Adapter	U43144	Steel	
			JIC 7/16-20 x 1/4" NPT, 90° Elbow Adapter	35528-1	Steel	
			JIC 3/4-16 x 1/4" NPT, 90° Elbow Adapter	35528-6	Steel	
			JIC 3/4-16 x 3/8" NPT, 90° Elbow Adapter	35528-7	Steel	
			JIC 7/16-20 x 1/8" NPT, Straight Adapter	U43124	Steel	
			JIC 9/16-18 x 1/4" NPT, Straight Adapter	U43146	Steel	
			JIC 9/16-18 x 1/4" NPT, 90° Elbow Adapter	35528-2	Steel	
			1/4" NPT(F) x 1/8" NPT(M), Straight Adapter	U1106A	Steel	
			JIC 7/16-20, Union Tee Adapter	35582-1	Steel	
	JIC 9/16-18, Union Tee Adapter	35582-2	Steel			
	4		1/4" O.D. Tube x 1/4" NPT, Straight Tubing Adapter	B10090-2	Steel	
1/4" O.D. Tube x 1/8" NPT, Straight Tubing Adapter			U83B1	Steel		
1/4" O.D. Tube x 1/4" NPT, 90° Elbow Tubing Adapter			U87B2	Steel		
1/4" O.D. Tube x 1/8" NPT, 90° Elbow Tubing Adapter			U87B1	Steel		
5	Manual Grease Fitting	1/8" NPT Grease Zerk Fitting, Straight	15332-1			
6	Tee	1/8" NPT(M) x 1/8" NPT(F) x 1/8" NPT(F) Male Run Tee	26978	Steel		
FEED LINE + SECONDARY	7		Hose	5/32" I.D. Flexible Hose	34962	For Hose End with Stand Pipe
			Tubing	1/4" O.D. Nylon Tubing x .062 Wall	70420-25	25' Length
			1/4" O.D. Nylon Tubing x .062 Wall	70420-325	325' Roll	
			1/4" O.D. Nylon Tubing x .062 Wall, Grease Filled	35127	25' Lengths	
			6mm O.D. Nylon Tubing 1.5mm Wall	731002173	Per Meter	
8		5/32" I.D. Hose Coupling x 3/16" Stand Pipe	29116			
		5/32" I.D. Hose Coupling x 1/4" Stand Pipe	29117			
		5/32" I.D. Hose Coupling x 1/4" Stand Pipe 90°	29220			
FEED LINE + SECONDARY LINE	9		1/4" O.D. TBG Outlet Fitting with Check Valve	35166	Compression	
			6mm O.D. TBG Outlet Fitting with Check Valve	23301	Compression	
			1/4" O.D. TBG Outlet Fitting Push to Connect with Check Valve	AR5116	Use with Nylon Tube	
			6mm O.D. TBG Outlet Fitting Push to Connect with Check Valve	AR5195	Use with Nylon Tube	
			1/8" NPT(F) Outlet Fitting with Check Valve	29076	Female NPT	
10	Outlet Plug for "B" Porting	Closure Plug – "B" Porting (Singling)	74161-1851	Use with Part #23292		
11	Clamping Ring for "B" Porting	Clamping Ring – Required for "B" Porting (Singling)	23292	Use with Part #74161-1851		

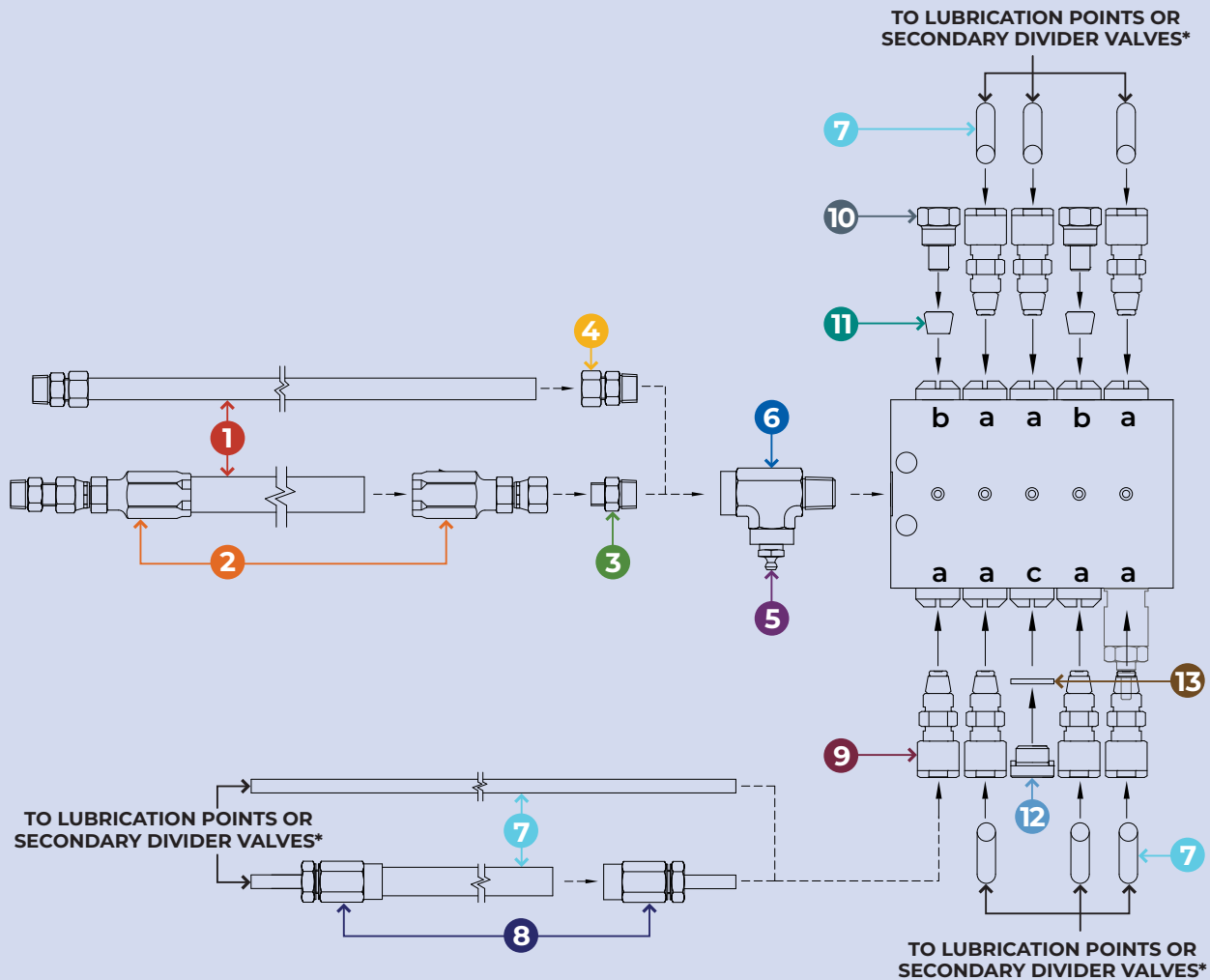









* See pages 12-15 for terminating fittings and miscellaneous components.

	NAME	DESCRIPTION	PART #	NOTES	
ACCESSORIES	12	Outlet Plug for "C" Porting	Closure Plug – "C" Porting	74161-5741	Use with Part #72712-1094
	13	Copper Seal for "C" Porting	Copper Seal – Required for "C" Porting	72712-1094	Use with Part #74161-5741
		Cycle Switch	Proximity Cycle Switch with LED (NPN) (Use with SMDC controller, Multiport II, or customer PLC)	66925S003*	* Use with cable part #76928-2863 or #76928-2833
			Proximity Cycle Switch with LED (PNP) (Use with pCo controller or customer PLC)	66925-1311*	* Use with cable part #76928-2863 or #76928-2833
		Cable, Straight, 10 Meters Long	76928-2863		
		Cable, 90°, 10 Meters Long	76928-2833		

NOTE: For additional information, see Datasheet #35635: PVBM Datasheet

VXLO Indirect Injectors

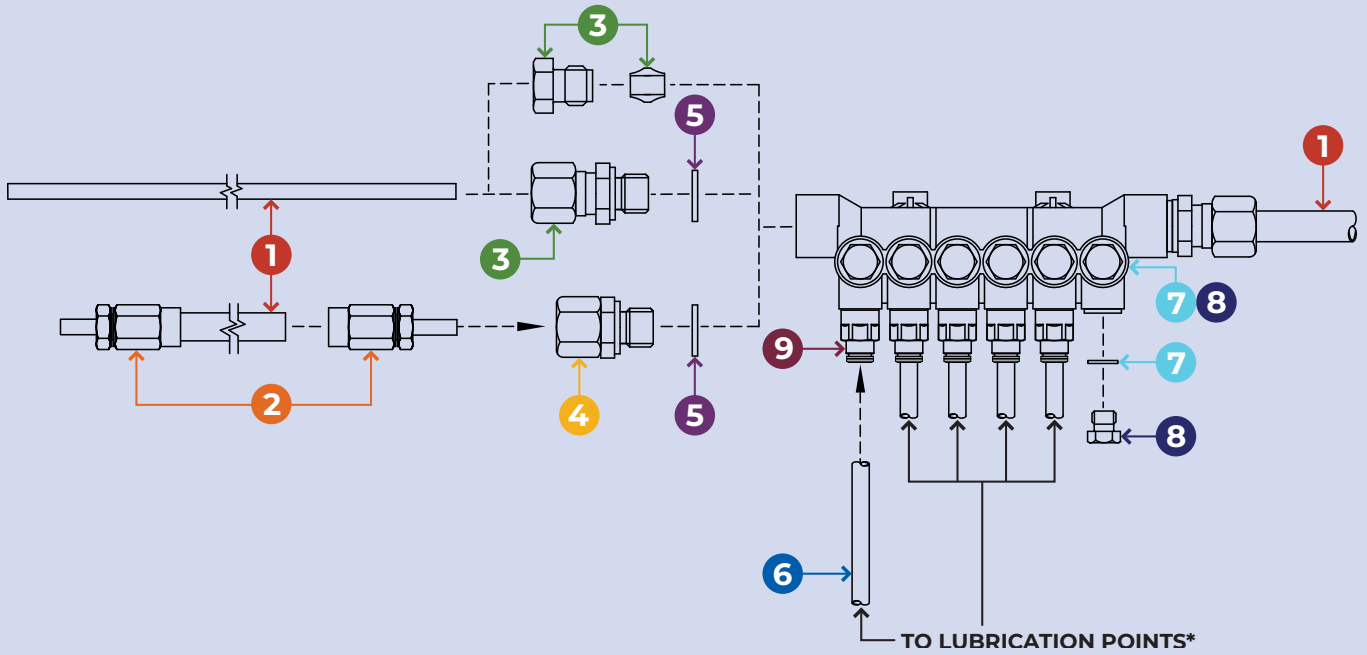

	NAME	DESCRIPTION	PART #	NOTES	
SUPPLY LINE	1	 Hose	1/4" I.D. Hose (6.4mm)	34964	3000 psi (Working Pressure)
		 Tubing	10mm O.D. nylon tubing	10N6-BLACK	600 psi (Working Pressure)
		Union	Connector	53560-1	Connect Multiple Injectors
	2	 Hose Ends	1/4" I.D.(6.4mm) Hose Coupling x 8mm Stand Pipe	34965	
	3	 Tubing Adapters	10mm O.D. Tube x M16 x 1.5, Straight Tubing Adapter	AR906	Use with Part #AR1124
			10mm O.D. Tube x M16 x 1.5, Banjo 90° Tubing Adapter	AR137	Use with Part #AR1124
			10mm O.D. Tube x M16 x 1.5, Compression Bushing	25568	Use with Part #25677
			10mm O.D. Compression Sleeve	25677	Use with Part #25568
		Adapters	M16x1.5 x 1/8NPTF Adapter	42444-5	
	4	Adapters	10mm O.D. Tube x 8mm O.D. Tube	AR806	
5	 Copper Washers	M16 x 1.5 Copper Washer	23483		
FEED LINE	6	 Tubing	4mm O.D. Nylon Tubing	19230	Black
				19230-RD	Red
				19230-BU	Blue
				19230-GN	Green
				19230-YW	Yellow
				19230-BR	Brown
	7	 O-rings	Injector Plug O-Ring	22100-21	Use with Part #47668
			Outlet O-Ring	22100-13	Use with Part #47673 or #53191
	8	 VXLO Plugs	VXLO Outlet Fitting Plug	47673	
			VXLO Injector Cap Plug	47668	
			VXLO Manifold Body Inlet Plug	45111	Use with 23483
	9	 Outlet Fitting	VXLO Push-to-Connect Outlet Fitting	36444	Replacement Outlet Fitting



* See pages 12-15 for terminating fittings and miscellaneous components.

NOTE: For additional information, see Datasheet #35584: *VXLO Datasheet*

M2500G Divider Valves

	NAME	DESCRIPTION	PART #	NOTES		
SUPPLY LINE	1	Hose	1/4" I.D. Hose (SAE 100R2)	U7184	5800 psi (Working Pressure)	
			3/8" I.D. Hose (SAE 100R2)	U7186	4750 psi (Working Pressure)	
	2	Tubing	3/8" O.D. Stainless Steel Tubing	7938049304WSS	20' Lengths	
			3/8" O.D. Steel Tubing	U424E6	20' Lengths	
	3	Hose Adapters	1/4" I.D. Hose x Female JIC Swivel 7/16-20	U43844	Steel	
			3/8" I.D. Hose x Female JIC Swivel 9/16-18	U43866	Steel	
				JIC 7/16-20 x 1/4" NPT, Straight Adapter	U43144	Steel
			JIC 7/16-20 x 1/4" NPT, 90° Elbow Adapter	35528-1	Steel	
			JIC 9/16-18 x 1/4" NPT, Straight Adapter	U43146	Steel	
			JIC 9/16-18 x 1/4" NPT, 90° Elbow Adapter	35528-2	Steel	
	4	Tubing Adapters	1/4" O.D. Tube x 1/4" NPT, Straight Tubing Adapter	B10090-2	Steel	
			3/8" O.D. Tube x 1/4" NPT, Straight Tubing Adapter	B10090-5	Steel	
				1/4" O.D. Tube x 1/4" NPT, 90° Elbow Tubing Adapter	B10092-1	Steel
			3/8" O.D. Tube x 1/4" NPT, 90° Elbow Tubing Adapter	U87D1	Steel	
5	Manual Grease Fitting	1/8" NPT Grease Zerk Fitting, Straight	15332-1	Use with B6131 Reducer		
6	Tee	1/4" NPT(M) x 1/4" NPT(F) x 1/4" NPT(F) Male Run Tee	19283	Steel		
FEED LINE + SECONDARY	7	Hose	34962-25	For Hose End with Stand Pipe (GFO= NLGI #0 grease filled)		
			34962-164			
			34962-82-GFO			
			34962-164-GFO			
	Tubing	1/4" O.D. Nylon Tubing x .062 Wall	70420-25	25' Length		
		1/4" O.D. Nylon Tubing x .062 Wall	70420-325	325' Roll		
1/4" O.D. Nylon Tubing x .062 Wall, Grease Filled		35127	25' Lengths			
6mm O.D. Nylon Tubing 1.5mm Wall		731002173	Per Meter			
8	Hose Ends	5/32" I.D. Hose Coupling x 1/4" Stand Pipe	29117			
		5/32" I.D. Hose Coupling x 1/4" Stand Pipe 90°	29220			
ACCESSORIES	9	Cycle Switch	Proximity Cycle Switch with LED (NPN) (Use with SMDC controller, MultiPort II, or customer PLC)	669255003*	* Use with cable part #76928-2863 or #76928-2833	
			Proximity Cycle Switch with LED (PNP) (Use with pCo controller or customer PLC)	66925-1311*	* Use with cable part #76928-2863 or #76928-2833	
			Cable, Straight, 10 Meters Long	76928-2863		
			Cable, 90°, 10 Meters Long	76928-2833		

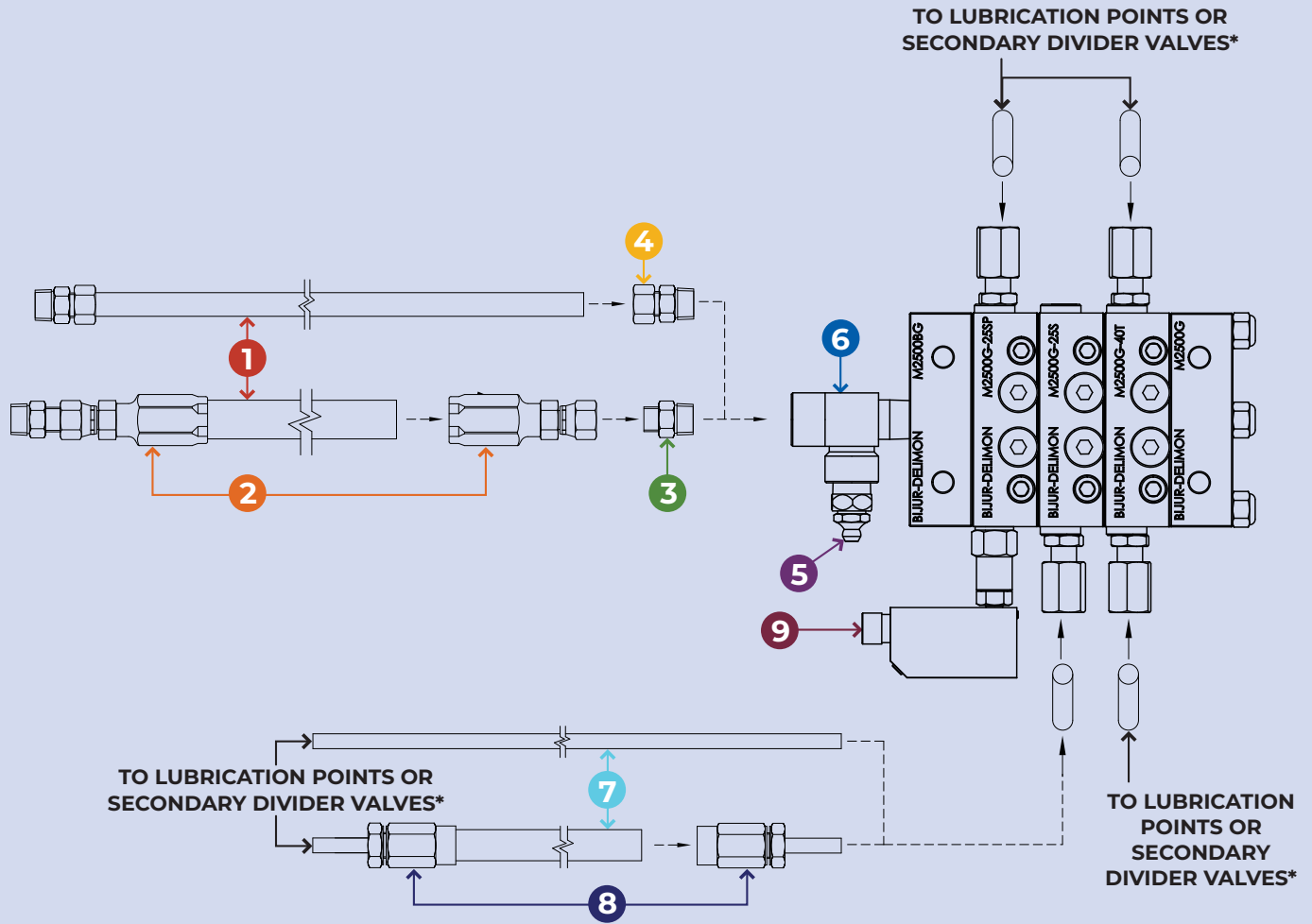



* See pages 12-15 for M2500G outlet and terminating fittings and miscellaneous components.

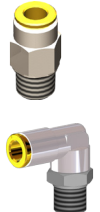

	NAME	DESCRIPTION	PART #	NOTES
ACCESSORIES	 Over Pressure Indicators	Over Pressure Indicator Relieving 1000 psi	213510	
		Over Pressure Indicator Relieving 1500 psi	213515	
		Over Pressure Indicator Relieving 2000 psi	213520	
		Over Pressure Indicator Non-Relieving 1200 psi	203512	
		Over Pressure Indicator Non-Relieving 1600 psi	203516	
		Over Pressure Indicator Non-Relieving 2200 psi	203522	

NOTE: For additional information, see Datasheet #35821: M2500G Datasheet & Catalog #SL2800

Miscellaneous



TERMINATING FITTINGS					SYSTEM TYPE				
NAME	DESCRIPTION	PART #	NOTES	CXL	FL	M25	VXLO	PVB	
Tubing Adapter Assembly 	3/16" O.D. Tube x 1/8" NPT, 90° Elbow Tubing Adapter	35438	Brass	X	X			X	
	3/16" O.D. Tube x 1/8" NPT, Straight Tubing Adapter	35435	Brass	X	X			X	
	3/8" O.D. Tube x 1/4" NPT(M), Tubing Adapter	U83D2	Steel			X			
	3/8" O.D. Tube x 1/4" NPT(M), 90° Elbow Tubing Adapter	U87D2	Steel			X			
	3/8" O.D. Tube x 1/4" NPT, Straight Tubing Adapter	35437	Brass			X			
	3/8" O.D. Tube x 1/4" NPT, 90° Elbow Tubing Adapter	35440	Brass			X			
	3/16" O.D. Tube x 1/8" NPT, Straight Tubing Adapter	U83A1	Steel	X	X			X	
	3/16" O.D. Tube x 1/4" NPT, Straight Tubing Adapter	U83A2	Steel	X	X			X	
	1/4" O.D. Tube x 1/8" NPT, Straight Tubing Adapter	U83B1	Steel	X	X	X		X	
	1/4" O.D. Tube x 1/4" NPT, Straight Tubing Adapter	B10090-2	Steel	X	X	X		X	
	3/16" O.D. Tube x 1/8" NPT, 90° Elbow Tubing Adapter	U87A1	Steel	X	X	X			
	3/16" O.D. Tube x 1/4" NPT, 90° Elbow Tubing Adapter	U87A2	Steel	X	X	X			
	1/4" O.D. Tube x 1/8" NPT, 90° Elbow Tubing Adapter	U87B1	Steel	X	X	X		X	
	1/4" O.D. Tube x 1/4" NPT, 90° Elbow Tubing Adapter	U87B2	Steel	X	X	X		X	
	3/16" O.D. Tube x 1/4-28, Straight Tubing Adapter	27717 + 35435	Brass/Steel	X	X	X		X	
	4mm O.D. Tube x 1/8" NPT, Straight Tubing Adapter	B3297	Brass				X	X	
	4mm O.D. Tube x 1/8" NPT, Straight Tubing Adapter	32995	Steel				X	X	
	4mm O.D. Tube x 1/8" NPT, 90° Elbow Tubing Adapter	B3298	Brass				X	X	
	3/16" O.D. Tube x 1/8" NPT(F), 90° Elbow Tubing Adapter	35445	Brass	X	X	X		X	
High Pressure Push to Connect 	1/4" Tube X 1/8NPT Straight	AR5206	Nickel-plated Brass	X	X	X		X	
	1/4" Tube X 1/8NPT 90° Swivel	AR5204		X	X	X		X	
	1/4" Tube X 1/4-28 Straight	AR5205		X	X	X		X	
	1/4" Tube X 1/4-28 90° Swivel	AR5207		X	X	X		X	
	6mm Tube X 1/8NPT Straight	AR5202		X	X	X		X	
	6mm Tube X 1/8NPT 90° Swivel	AR5194		X	X	X		X	
	6mm Tube X 1/4-28 Straight	AR5221		X	X	X		X	
	6mm Tube X 1/4-28 90° Swivel	AR5223		X	X	X		X	
	4mm Tube X 1/8NPT Straight	AR5227					X		
	4mm Tube X 1/8NPT 90° Swivel	AR5225					X		
	4mm Tube X 1/4-28 Straight	AR5228					X		
	4mm Tube X 1/4-28 90° Swivel	AR5226					X		
	STAINLESS STEEL								
Hose Ends 	1/4" I.D. hose x female JIC swivel 7/16-20	35637-1		X	X	X		X	
	3/8" I.D. hose x female JIC swivel 9/16-18	35637-2		X	X	X		X	
	1/2" I.D. hose x female JIC swivel 3/4-16	35637-3		X	X				

STAINLESS STEEL

NAME	DESCRIPTION	PART #	NOTES	CXL	FL	M25	VXLO	PVB
Hose Adapters (Straight) 	JIC 7/16-20 x 1/4" NPT, Straight Adapter	35638-1		X	X	X		X
	JIC 9/16-18 x 1/4" NPT, Straight Adapter	35638-2		X	X	X		X
	JIC 9/16-18 x 1/4" NPT, Straight Adapter	35638-3		X	X	X		X
	JIC 9/16-18 x 3/8" NPT, Straight Adapter	35638-4		X	X	X		X
	JIC 7/16-20 x 1/8" NPT, Straight Adapter	35638-5		X	X	X		X
	JIC 3/4-16 x 1/4" NPT, Straight Adapter	35638-6		X	X			
	JIC 3/4-16 x 3/8" NPT, Straight Adapter	35638-7		X	X			
	JIC 9/16-18 x 1/8" NPT, Straight Adapter	35638-8		X	X			
Hose Adapters (Elbow) 	JIC 7/16-20 x 1/4" NPT, 90° Elbow Adapter	35636-1		X	X	X		X
	JIC 9/16-18 x 1/4" NPT, 90° Elbow Adapter	35636-2		X	X	X		X
	JIC 7/16-20 x 3/8" NPT, 90° Elbow Adapter	35636-3		X	X	X		X
	JIC 9/16-18 x 3/8" NPT, 90° Elbow Adapter	35636-4		X	X	X		X
	JIC 7/16-20 x 1/8" NPT, 90° Elbow Adapter	35636-5		X	X	X		X
	JIC 3/4-16 x 1/4" NPT, 90° Elbow Adapter	35636-6		X	X			
	JIC 3/4-16 x 3/8" NPT, 90° Elbow Adapter	35636-7		X	X			
	JIC 9/16-18 x 1/8" NPT, 90° Elbow Adapter	35636-8		X	X	X		X





MISCELLANEOUS COMPONENTS

SYSTEM TYPE

NAME	DESCRIPTION	PART #	NOTES	CXL	FL	M25	VXLO	PVB
Tubing Unions 	1/4" O.D. Tube Union	U84B	Steel	X	X			X
	3/16" O.D. Tube Union	35441	Brass	X	X	X		X
	3/8" O.D. Tube Union	35442	Brass			X		
	3/8" O.D. Tee Tube Union	35444	Brass			X		
	4mm O.D. Tube Union	20657	Brass				X	
Compression Nuts 	3/16" O.D. Tube Nut with Captive Sleeve	35433	Brass	X	X	X		X
	3/8" O.D. Tube Nut with Captive Sleeve	35434	Brass			X		
Adapters 	1/8" NPT x 1/4-28, Straight Adapter	27717	Steel	X	X	X		X
	1/8" NPT x 1/4-28, 90° Adapter	27718	Steel	X	X	X		X
	1/8" NPT x 1/8" NPT, 90° Adapter	A2768	Brass	X	X	X		X
	1/8" NPT x 1/8" NPT, 45° Adapter	B3133	Brass	X	X	X		X
	1/8" NPT x 1/8" NPT, 90° Adapter	U1104AS	Steel	X	X	X		X
	1/4" NPT x 1/4" NPT, 90° Adapter	U1104B	Steel	X	X	X		X
	1/8" NPT x 1/8" NPT, 45° Adapter	U1103A	Steel	X	X	X		X
	3/8" NPT x 3/8" NPT, 90° Adapter	U1104C	Steel	X	X	X		X
	1/4" NPT x 1/4" NPT, 45° Adapter	U1103B	Steel	X	X	X		X
	1/8" NPT Extension, 3/4" LG	A3920	Brass	X	X	X		X
	1/8" NPT Extension, 1-1/4" LG	A2540	Brass	X	X	X		X
	1/8" NPT Extension, 3/4" LG	35629-1	Steel	X	X	X		X
	1/8" NPT Extension, 1-1/4" LG	35629-2	Steel	X	X	X		X

Miscellaneous

MISCELLANEOUS COMPONENTS				SYSTEM TYPE				
NAME	DESCRIPTION	PART #	NOTES	CXL	FL	M25	VXLO	PVB
Adapters (Contin.)	1/8" NPT(F) Swivel x 1/8" NPT(M)	32382-1	Steel	X	X	X	X	X
	1/4" NPT(F) Swivel x 1/4" NPT(M)	35578	Steel	X	X	X	X	X
	1/4" NPT(M) x 1/4" NPT(F) x 1/4" NPT(F) Male Run Tee	19283	Steel	X	X	X		X
	Press on Zerk Adapter x 1/8" NPT(F)	35160	Steel	X	X	X		X
	Zerk Adapter with 90° Elbow Adapter (Part #35438)	35160+ 35438	Steel/Brass	X	X	X		X
	Zerk Adapter with Straight Adapter (Part #35435)	35160+ 35435	Steel/Brass	X	X	X		X
Plugs 	1/8" NPT Plug Hex Head	35573-1	Steel	X	X	X		X
	1/4" NPT Plug Hex Head	35573-2	Steel	X	X	X		X
	3/8" NPT Plug	U119CC	Steel		X	X		X
Nipples 	3/8" NPT Nipple Hex	32485-1	Steel	X	X	X		X
	1/4" NPT Nipple Hex	32485-2	Steel	X	X	X		X
	1/8" NPT Nipple Hex	32485-3	Steel	X	X	X		X
	1/4" NPT x 1/8" NPT Nipple Hex	32485-4	Steel	X	X	X		X
Anchor Blocks 	1/4" NPT, Block (1-1/2" x 1-1/2" x 1")	BLK11689A	9/32" Mounting Hole	X	X	X		X
	1/8" NPT, Block (1-1/2" x 1-1/2" x 1")	BLK11688A	9/32" Mounting Hole	X	X	X		X
Loom, Straps & Clamps     	Heavy Duty, Nylon, Cable Tie	24534-1	14" LG	X	X	X	X	X
	Standard Duty, Nylon, Cable Tie	HE1132-1	7.3" LG	X	X	X	X	X
	1/4" Loom	35419-1		X	X	X	X	X
	1/2" Loom	35419-2		X	X	X	X	X
	3/4" Loom	35419-3		X	X	X	X	X
	1" Loom	35419-4		X	X	X	X	X
	5/8" Clamp	35448-4	Use with Part #U7184	X	X	X	X	X
	3/4" Clamp	35448-5	Use with part #U7186	X	X	X	X	X
	3/8" Clamp	35448-2	Use with 3/8" O.D. Tube	X	X	X	X	X
	1/4" Clamp	35448-1	Use with 3/16" O.D. Tube	X	X	X	X	X
	1/2" Clamp	35448-3	Use with 3/16" Tube Bundles	X	X	X	X	X
	1/2" Spiral Wrap, Black	35645	3/8" to 4" Bundling Range	X	X	X	X	X
	1" Spiral Wrap, Black	35646	1" to 7" Bundling Range	X	X	X	X	X
	Gauges 	5000 psi, 1/4" NPT LM	U902F	Lower Mount	X	X		
5000 psi, 1/4" NPT CBM		U902FB	Center Back Mount	X	X			X
3000 psi, 1/4" NPT LM		U902D	Lower Mount			X		
3000 psi, 1/4" NPT CBM		U902DB	Center Back Mount			X		
2000 psi, 1/8" NPT LM		U902J	Lower Mount				X	

MISCELLANEOUS COMPONENTS				SYSTEM TYPE				
NAME	DESCRIPTION	PART #		CXL	FL	M25	VXLO	PVB
Pressure Switches 	1/4" NPT N.O. Set at 600 psi	35517-1				X	X	
	1/4" NPT N.O. Set at 2000 psi	35517-2		X	X			X
Miscellaneous 	Deutsch Plug Assembly with 25' of Wire	35559	Use with SMDC	X	X	X		X
	Cable Electric SJO 16/4	15117-5		X	X	X	X	X
	LED Indicator (12 VDC)	35734-1	(Old #35572-1)	X	X	X	X	
	LED Indicator (24 VDC)	35734-2	(Old #35572-2)	X	X	X	X	
	1/8" NPT Grease Fitting, Straight	15332-1				X		X
	1/8" NPT Grease Fitting, 90°	15332-2				X		X
	1/4" NPT Grease Fitting, Straight	F687				X		X
	1/4" NPT Grease Fitting, 65°	F689				X		X
	1/4" O.D. Nylon Tubing Insert	B144-6		X	X			X
	4mm O.D. Nylon Tubing Insert	22585-1					X	
10mm O.D. Nylon Tubing Insert	22585-3					X		
Manual Fill Pumps 	Fits 120 lb. Drum	37303		X	X	X	X	X
	500 psi Fits 35 lb. Pail	37304		X	X	X	X	X
MultiPort Accessories 	3600 psi relief valve	22474		X	X	X	X	X
	3000 psi relief valve	22474-4		X	X	X	X	X
	2000 psi relief valve	22474-3						
	1000 psi relief valve	22474-2		X	X		X	
	MP/MP2 90° mounting plate	37431		X	X	X	X	X
	MP/MP2 mounting plate	55389		X	X	X	X	X
Grease Guns	Standard Grease Gun	F1205		X	X	X		X
	Manual grease gun - Push Gun*	F40534		X	X	X		X
	Adapter, DYX/MP/MP2 - M22x1.5	F80223		X	X	X		X
	Adapter 1/4"NPT	37643		X	X	X		X

*F40534 Push Gun allows Pump Reservoirs to be refilled using standard grease cartridges. The Push Gun mates with connector F80223, which can be installed in a spare pump element port (M22x1.5) in pumps such as Dynamis Maxx, MultiPort, and Multiport II. Adapter 37643 allows connector F80223 to be installed on pumps that have a 1/4" NPT fill port.

Innovators of engineered lubrication technology **since 1872**

Bijur Delimon International has ISO 9001:2015 and ISO 14001:2015 quality certified manufacturing facilities around the world, so your centralized lubrication system meets the highest industry quality standards. It's all part of our commitment to quality and customer service.

OUR INDUSTRY LEADING FAMILY OF BRANDS



DELIMON

Farval®

 **LubeSite®**



GLOBAL HEADQUARTERS

Bijur Delimon International
1 Copley Parkway, Suite 104
Morrisville, NC 27560

(919) 465 4448 **LOCAL**
(800) 631 0168 **TOLL-FREE**
(919) 465 0516 **FAX**

WWW.BIJURDELIMON.COM

35544 • R13 02/22