



BIJUR DELIMON[®]
INTERNATIONAL



SUREFIRE SLR

Centralized Lubricating System

- + SureFire SLR Automatic Lubricator
- + Resistance Fittings
- + Distribution Components
- + Accessories

Contents

Protect Expensive Machinery	3
SureFire SLR Lubricator	4
On-board Controller/Monitor	6
Timer	7
Selecting Resistance Fittings	8
Meter Units	10
Control Units	11
Junctions	12
Fittings & Spare Parts.....	14
Tubing & Accessories.....	16
Flexible Hose	17
Dimensional Schematics	18
Notes.....	22

CAPABLE OF
PUMPING
PRECISE
AMOUNTS OF
OIL TO AS
MANY AS 100
LUBRICATION
POINTS

Protect Expensive Machinery

System Description

SureFire SLR low pressure oil lubrication systems are designed for light, medium and heavy machinery requiring up to 100 points of lubrication. They are ideally suited for machinery requiring an uninterrupted discharge of oil, either regularly-timed or continuous.

The Bijur Delimon SureFire SLR centralized lubrication system is a reliable SLR system that consists of three basic elements:

- + **SureFire SLR lubricator pump** – stores and pumps lubricant
- + **Resistance fittings** – allows a proportioned amount of oil to flow to a lubrication point
- + **Lubricant distribution network** – tubing, junctions, adapters, clips and connector hardware

Each part of the SureFire SLR centralized lubrication system is an important piece of the lubrication puzzle.

SureFire SLR Lubricator

The SureFire SLR lubricator provides the central source of oil or fluid grease for the centralized lubrication system. It includes a reservoir to store the lubricant and a pump that pressurizes the lubricant through the system.

Resistance Fittings

Bijur Delimon offers meter units and control units to dictate the amount of oil that flows into a lubrication point. These fittings are available in a wide array of sizes, configurations and flow rates. Use meter units for cyclic SLR systems and control units for continuous SLR systems.

Lubricant Distribution Network

There is an extensive accessory catalog available to support the SureFire SLR centralized lubrication system. Everything from tubing and junctions to adapters and connection hardware can be ordered with the SureFire SLR system, or ordered from a Bijur Delimon representative when the need arises.

SureFire SLR helps lubricate many industrial applications:

- + Machine Tools
- + Metal Forming
- + Printing Machinery
- + Automotive
- + Plastics Machinery
- + Aerospace/Aviation
- + Textiles
- + Injection Molding

Note!

SureFire lubricator is also available for use with Positive Displacement Injector (PDI) applications. Refer to *Brochure #200: SureFire PDI* for more information.

SureFire SLR Lubricator

The heart of the SureFire SLR centralized lubrication system is the robust and durable SureFire SLR lubricator. Designed specifically for oil applications, and available in four reservoir capacities to fit your space requirements and lubrication demands, the SureFire SLR lubricator is a self-contained electric motor-driven gear pump that can adapt to a broad range of production machinery. It can handle single resistance fittings or resistance fitting groups that serve up to 100 lubrication points. Its versatility also allows it to perform with other lubrication systems and applications.

Benefits

The SureFire SLR lubricator is designed with the user in mind. It has a unique and flexible modular construction that makes it user-friendly.

- + Multiple voltage options:
 - + Single phase: 115 VAC, 230 VAC, 24 VDC
 - + Three phase: 230/480 VAC
- + Outlet connections on both sides facilitate quick installations
- + Quick-snap reservoir release clips let you quickly remove the unit for service and provide easy access for servicing and replacement of key components
- + Large fill cap and built-in strainer allows for faster filling and fewer spills
- + Liquid level, pressure relief valve and pressure gauge (included)
- + Pressure switch for single phase models (optional)
- + Cast base and sealed electric motor enclosure protect working components from contamination
- + Programmable controller/monitor (optional on single phase models)
- + Three phase models have a fully adjustable pressure regulating valve with a 0 to 25 bar range
- + Two controller versions available

SUREFIRE SLR SINGLE PHASE



SUREFIRE SLR THREE PHASE



Figure 1: Hydraulic Schematic
Standard Single Phase SureFire SLR

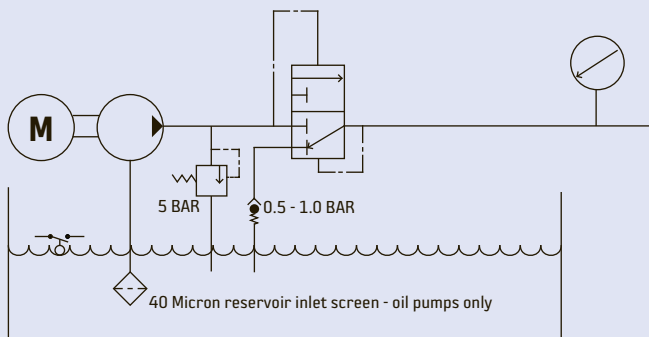
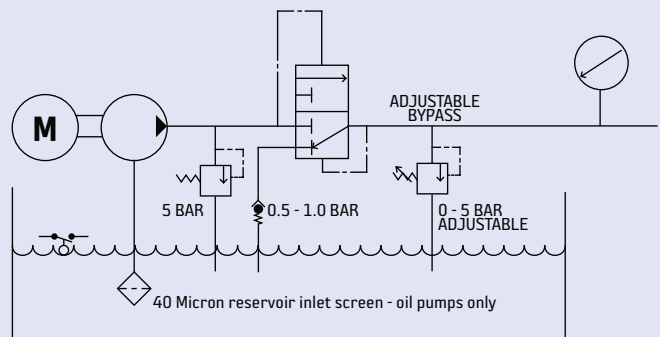

Figure 2: Hydraulic Schematic
Standard Three Phase SureFire SLR



How it Works

When power is supplied to the motor (via either an on-board timer on controller or by customer-supplied power) the motor runs the gear pump. As the motor turns, the gear pump pulls lubricant in from the reservoir and delivers pressurized lubricant to the distribution network via the outlet(s) in the top plate. Pressurizing the distribution network forces all the resistance fittings in the system to open, allowing lubricant to flow to the friction points. The resistance fittings continue to flow and the pump builds pressure until pressure relief valve setting is reached (75 psi or 130psi 3-Phase). Once the motor is shut off, pressure in the distribution network returns to near 0 psi. This actuates a quick dump valve which relieves the line pressure back into the reservoir.

Note: Depending on SureFire model selected, motor voltage options will determine pump output (i.e. cyclic or continuous).

Technical Data

Output volume - 115 VAC, 230 VAC (max.)¹	200cc/min @ 60 Hz (167cc/min @ 50 Hz)
Output volume - 24 VDC (max.)¹	250cc/min
Output volume - Three phase (max.)¹	200 or 500cc/min @ 60 Hz; 167 or 415cc/min @ 50 Hz
Output pressure (max.)	5 bar (75 psi) 8.9 bar (130 psi) 3-Phase models
Pressure switch setting^{2,3}	Optional, closes at 1.4 ±0.3 bar (20 ±5 psi)
Lubricant viscosity	Oil: 20 to 1500 cp
Reservoir fill screen (oil only)	40 mesh, removable
Reservoir volume	1.8 liter, 2.7 liter, 6.0 liter, 12.0 liter
Reservoir material	Clear Terlux Plastic for 1.8, 2.7 and 6.0 liter, Steel for 12.0 liter
Motor voltage options	115 VAC, 230 VAC 50/60 Hz, 24 VDC (single phase) 230/415 VAC 50 Hz, 260/480 VAC 60 Hz (three phase)
Motor power requirements^{4,5}	Approximately 140 watts
Operating temperature range	+5°C through +40°C (+40°F through 105°F)
IP rating	IP-54
Electrical fitting	Liquid tight
Output connection	G 1/4 BSPP
Single (main) feed line	6mm O.D. minimum recommended

¹ Typical pump output is ~3cc/sec with pump on for 20-30 sec with 100+ points and 1/4" main line.

² Pressure switch is optional on single phase models. Not available on three phase models.

³ External end-of-line pressure switch also available (Part #26641-2; 55 psi).

⁴ Only applies to SureFire SLR single phase models.

⁵ Motor Overload Protection needs to be provided by the host machine and/or its control system.

IMPORTANT!

The electrical circuit for the level switch for oil must not exceed 10 watts.

How to Order

The SureFire SLR lubricator features a smart part number ordering system, where you can tailor the pump to meet your needs. First, choose the reservoir capacity, distribution system, options, controller type, voltage and wiring you need. Then, put the numbers into the corresponding squares in the easy-to-use grid. You now have the customized part number.

Example: To order a 1.8 liter reservoir with a restrictive/SLR distribution system, standard options, terminal block controller and a 115 VAC motor, you would use Part #SF2ANAC.

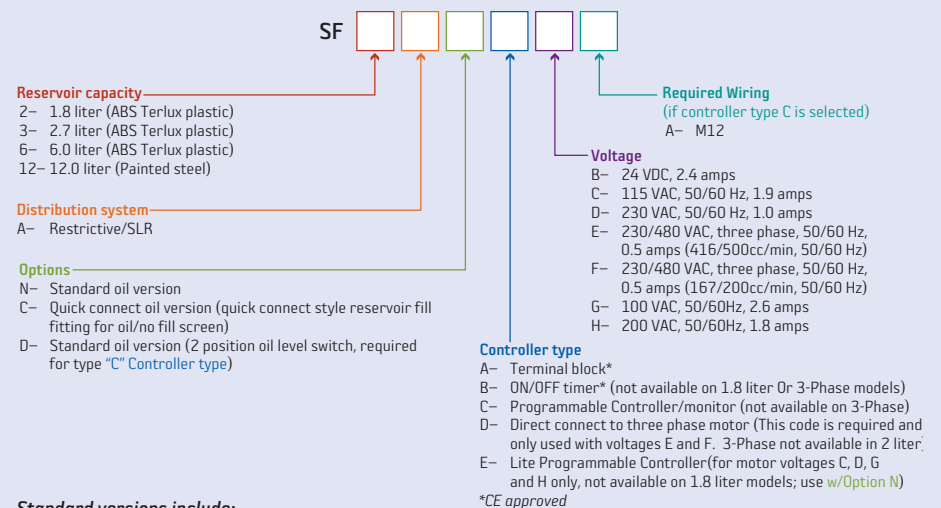

Standard versions include:

Float type reservoir, low level switch, standard reservoir fill-cap screen, 75 psi pressure relief valve (130psi 3-Phase).

On-board Controller/Monitor

SureFire with Standard Controller/Monitor

Features

The on-board controller/monitor is available on single phase models of SureFire and is designed to precisely control the lubrication to a piece of equipment. It does this by controlling the pump's cycle time, monitoring both internal and external inputs or switches, detecting and reporting faults and offering visual feedback that can be continuously updated and improved to enhance the user's experience with the product. Four languages are available on the screen for global use (English, German, French, Spanish).

The microprocessor-based controller allows users to:

- + Manage the on-times and the off-times of the pump.
- + Provide prelube functionality on start up.
- + Detect and respond to various input signals.
- + Display in real time the status of the pump at any time.
- + Monitor for faults in the system.
- + Provide output signals for feedback to the controlling machine.

The controller also features the protection of settings, through password-based security, protection of motors with limited duty cycles and restoration of default settings if required.

Operation

The SureFire PDI lubricator with on-board controller/monitor may be operated in two modes - TIMER mode and CONTROLLER mode. In TIMER mode, the user sets the pump on-time and the pump off-time. In CONTROLLER mode, the pump on-time is dependent on the pressure hold time, while the pump off-time may either be time-based or event-based. Both modes are subject to the non-disabling WARNING LEVEL fault and the disabling LOW LEVEL and AIR PRESSURE faults. In addition, CONTROLLER mode monitors the function of the OIL PRESSURE switch and will fault if necessary.

Parameters are set using the five key switches mounted on the front of the pump. By following the on-screen prompts, the user may navigate through menus, set various parameters, enable/disable various switches and select fault monitoring output schemes. Left and right arrow keys are typically used to navigate through screens, forwards and backwards, while up and down arrow keys are used to increase and decrease particular values or to enable/disable functions. The asterisk key is used mainly to save settings and to move on to the next screen.

The controller software has been written specifically to enable the user to navigate through screens without the help of a manual as it provides on-screen prompts on all screens. The controller is equipped with a backup battery and may be configured in various ways to deal with a power outage and subsequent power restoration.

SUREFIRE SLR SINGLE PHASE WITH STANDARD CONTROLLER



Refer to *Operators Manual #35462: Controller* for more detailed operating instructions.

SureFire Lite Controller/Monitor

Features

The SureFire Lite Controller is a multi-purpose programmable controller only available on single phase units. Controller settings are saved whenever power is interrupted. Up to four operating modes can be selected which allows the controller to be used with various lubrication system designs.

- + Digital status display on front cover for easy programming
- + System monitoring capabilities
- + Data memory function initiated at power down
- + Compact design

Operation

Keys Description



With the controller energized:

- + Press keys **S** and **R** simultaneously and release to enter control mode.
- + The display panel will now show a fixed letter for the selected mode and a flashing number (1-4).
- + To select the required mode press the ▲ key.
- + Press the **S** key to advance to the next parameter of the selected mode.
- + Repeat steps 3 and 4 above using the ◀▶ key to move across the digits and the ▲ key to change the value of the selected flashing digit.
- + On completion, press the **R** key to save the data and initiate a lubrication cycle.

Manual Override

- + With the controller energized press the **R** key to initiate a lubrication cycle.

Program Review

- + To review the preset data, press the **S** key repeatedly with the controller energized.
- + To return to operating condition display, release **S** key or depress **S** key for 5 seconds.

Fault Alarm

- + In any alarm condition, e.g. low level, low pressure etc., the pump will not be able to operate and the alarm lamp will illuminate. The fault condition must be rectified to cancel the alarm and reactivate the system.

SUREFIRE SLR SINGLE PHASE WITH LITE CONTROLLER



Refer to *Supplement #35989: SureFire Lite Controller* for more detailed operating instructions.

SureFire Controller/Monitor Screen

Standard Version

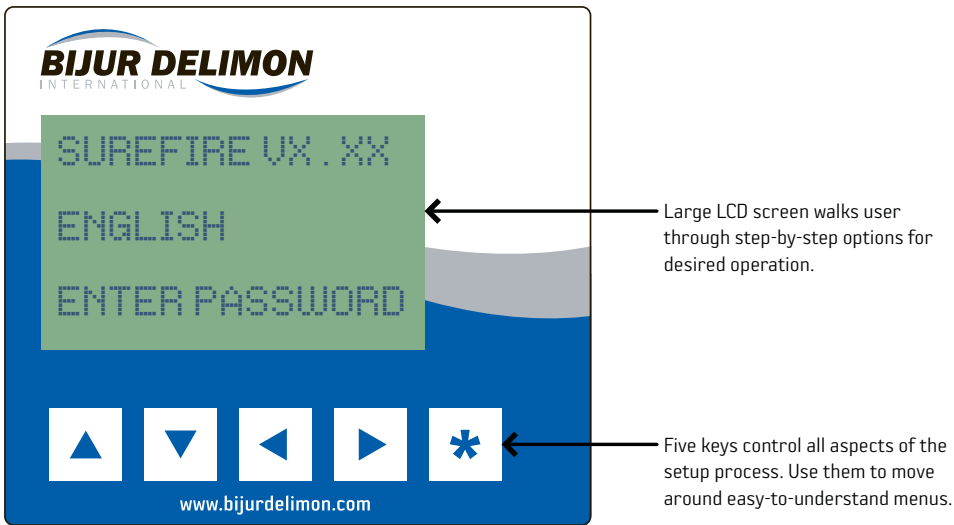

Lite Version

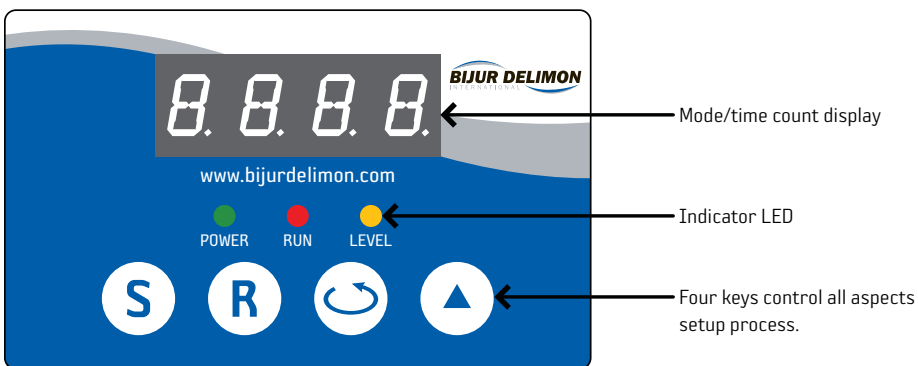

Accessories

Field-wireable M12 Connectors

Part #	Configuration	Pins (qty)
23694	Straight	5
23694-1	Angled	5
23837	Straight	8
23842	Angled	8

Cables

Part #	Description
M125A02U75	Cable power, 2 meters long, 90 degree plug
M125S02U75	Cable power, 2 meters long, straight plug
M128A02U25	Cable signal, 2 meters long, 90 degree plug
M128S02U25	Cable signal, 2 meters long, straight plug

Note: 3, 5 and 10 meter cable lengths are also available.

ATTENTION

Accessories for Standard Controller version only.



Timer

SureFire with Timer

The SureFire SLR lubricator is also available with an ON/OFF timer to provide basic timing functions, as detailed below:

- + ON time range = 0.1 seconds to 100 hours
- + OFF time range = 0.1 seconds to 100 hours
- + ON and OFF time settings are adjusted with dials, using a screwdriver
- + Upon power up, timer begins with ON time settings
- + Timer is wired at the factory in series with each motor and will handle the maximum amp draw of each motor used (no fusing is required)
- + Customer simply connects (+) and (-) power to the lubricator terminal block

Refer to *Supplement #35144: SureFire On/Off Timer* for more detailed operating instructions.

Selecting Resistance Fittings

Overview

Before designing your SureFire SLR system, it is critical to understand the function of resistance fittings and why they are important to your machinery.

Each resistance fitting is a fixed component designed for one-way delivery of a precise quantity of oil to a bearing or surface.

Also, the amount of oil delivered to each bearing point is apportioned by the resistance fitting, not the pump. The lubricator controls the volume of oil available for overall system consumption.

Each lubrication point on the machine must have an assigned resistance fitting. The size of the resistance fitting depends upon the calculated oil requirement for that bearing and relative proportioning ratios of the rest of the system (see Table 1).

Caution: A single resistance fitting can supply oil to only one point.

Nomenclature

Bijur Delimon refers to the resistance fittings used with automatic cyclic systems as meter units. Each meter unit is shipped

with a fixed orifice, a moving pin and an internal check valve. The valve ensures precise discharge without loss of system priming between operating cycles (see Figure 1). The orifice and pin size create the metering rate.

The resistance fittings used with continuous systems are called control units. Each control unit proportions a continuous rate of flow and does not contain a check valve (see Figure 2). The rate of flow at each point is controlled by the size of the spiral opening in the control unit.

Both types of Bijur Delimon resistance fittings (meter and control units), may be mounted in any position without affecting operation.

Selection

All Bijur Delimon resistance fittings have been designed to provide the proper amount of resistance to the flow of oil as it passes through it. The amount of resistance determines the amount of lubricant which each point receives. If the proper sized resistance fittings are selected, measured amounts of lubricant will provide adequate protection for your machinery.

TABLE 1

Calculating Oil Requirement

Bearing Type	Calculate Oil Requirement (cc/hour) by Multiplying
Anti-friction bearing	0.10 x bearing shaft diameter (") x number of rows (balls, rollers, etc.)
Plain bearings and drive screws	0.15 x bearing shaft diameter (") x bearing length (")
Gears	0.30 x gear pitch diameter (") x face width (")
Cams	0.08 x surface area (sq. in.)
Chains	0.05 x length (") x width (")
Slides and way flat	0.04 x [length of moving member (") + travel (")] x width (")
Cylindrical	0.15 x diameter (") x [length of moving member (") + travel (")]
Ball bearing	0.03 x travel of moving member (") x number of rows

Figure 1: Meter Unit (Type F)

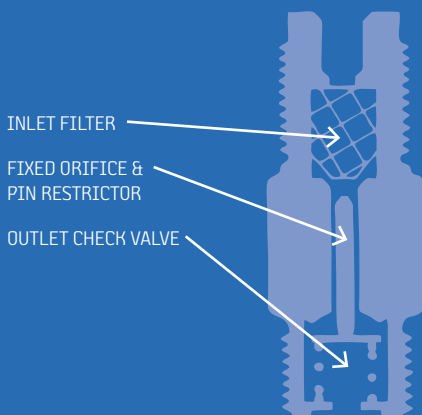
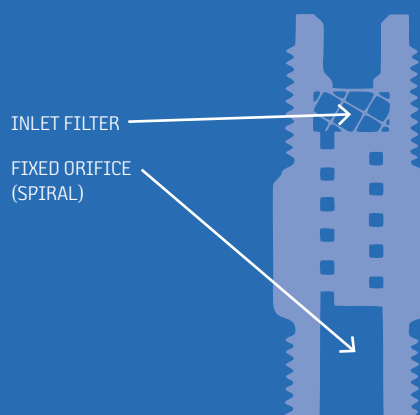

Figure 2: Control Unit (Type C)



Notes:

Refer to *Brochure #258: Single Line Resistance Systems* for information about verifying system capability.

SureFire SLR can be used as a continuous system when using a 24 VDC or three phase motor. Use control units in these systems.

It is important to specify the proper sized resistance fitting for each point in the system since both over- and under-lubrication can seriously affect machine operation and life. All Bijur Delimon resistance fittings are clearly marked for type of mounting and rate of flow.

Mounting

Both meter units and control units may be installed in any of three basic configurations:

1. **Straight** - mounted at the bearing
2. **Tee junction** - mounted at the bearing
3. **Junction** - removed from the bearing friction point

Each type resistance fitting is engineered to deliver a predictable and repeatable flow of oil to a bearing point regardless of its distance from the lubricator or pump.

Flow Rate/Value

Flow rate is a designation assigned to a resistance fitting and is identified by a stamped arrow on the body of the unit. Flow rate describes the relative oil flow from the unit. Each numeric increase doubles flow delivery from the unit.

Flow value is simply a numeric designation used to refer to the oil permitted to flow through the resistance fitting. The value is relative and does not correlate to either volumetric discharge or amount of discharge on a unit/time basis. Flow value is designated by the Greek letter Φ (phi).

This provides a convenient method of sizing pumps and resistance fittings in the system.

System Type

Resistance fittings should match the type of system you are designing. For example, a continuous loss system would typically require proportioning devices with ratings from 5/0 to 0; a cyclic system from 3/0 to 3; and a continuous re-circulating system from 1 to 5 (see Table 2).

Bijur Delimon offers a total of ten different sizes of resistance fittings ranging from very slow discharge (size 5/0) to very fast discharge (size 5) (see Table 3).

When designing your system, it is important to understand that each increase in flow rate doubles the relative flow value and thus, doubles the amount of oil delivered. For example, a 3/0 unit delivers twice as much oil as a 4/0 unit.

TABLE 2

Recommended Flow Rates

Flow Rate	Relative Proportional Delivery Rate	
5/0	1	CONTINUOUS "LOSS"
4/0	2	
3/0	4	CYCLIC "LOSS"
00	8	
0	16	CONTINUOUS "RE-CIRCULATING"
1	32	
2	64	
3	128	
4	256	
5	512	

TABLE 3

Flow Delivery & Value

Flow Rate	Relative Discharge Rate	Flow Value (Φ)
5/0	Extra, extra slow	0.3
4/0		0.6
3/0	Slow	1.2
00	Medium slow	2.5
0		5
1		10
2	Medium fast	20
3	Fast	40
4		80
5	Extra, extra fast	160

How to Order

Meter and control units have a letter and number designation stamped on the flat surface of the hexagonal body. Part numbers are listed in the tables on pages 10 and 11.

When ordering, specify the complete name and part number, e.g. Meter Unit, Type FSA-0, Part #B1083. (Use the chart to the right as reference only for letter and number designation definitions.)

Unit & Thread Type

- C- Control Unit
- F- Imperial thread*
- A- Metric thread*

Type, Location & Mating Parts

- B- British Thread Tee-Type
- F- High Flow Type**
- J- Junction Type
- K- Insert Type
- R- Reverse Flow Type
- S- Straight Type
- T- Tee Type

Flow Rate

- 5/0- Extra, extra slow**
- 4/0- **
- 3/0- Slow
- 00- Medium slow
- 0-
- 1-
- 2- Medium fast
- 3- Fast
- 4-
- 5- Extra, extra fast

* Meter Unit only
** Control Unit only

See *Datasheet #35470: Meter Units* and *Datasheet #35478: Control Units* for more information regarding type, location and mating parts.

Meter Units



FLOW	FSA	FSB	FJB	FJC	FJD	FKA	FKB	FKD	FKE	FRA	FRC	FB
3/0	B6526	B8717	B6548	B7267	B6085	B7271	B7273	B8878	B8868	B7265	B7269	B8724
00	B1620	B8718	B2494	B3314	B3773	B3913	B3980	B8870	B8860	B2559	B3579	B8725
0	B1083	B8455	B2495	B3315	B3774	B3914	B3981	B8871	B8861	B3215	B3580	B2452
1	B1084	B8719	B2496	B3316	B3775	B3915	B3982	B8872	B8862	B3216	B3581	B8726
2	B1085	B8720	B2497	B3317	B3776	B3916	B3983	B8873	B8863	B3217	B3582	B8727
3	B1086	B8721	B2498	B3318	B3777	B3917	B3984	B8874	B8864	B3218	B3583	B8728
4	B1087	B8722	B2499	B3319	B3778	B3918	B3985	B8875	B8865	B3219	B3584	B8729
5	B1088	B8723	B2500	B3320	B3789	B3919	B3986	B8876	B8866	B3220	B3585	B2730



FLOW	ASA	AJB	FT	FTA	FTB	FTC	FTD	FTG	FTH	FTK	FTL
3/0	17841-3/0	15323-3/0	B6529	B6549	B6550	B6551	B6552	B6553	B6554	B6555	B6556
00	17841-00	15323-00	B1398	B1524	B1528	B1530	B1532	B2759	B2769	B4128	B4368
0	17841-0	15323-0	B1112	B1071	B1077	B1098	B1106	B2760	B2770	B4129	B4369
1	17841-1	15323-1	B1113	B1072	B1078	B1099	B1107	B2761	B2771	B4130	B4370
2	17841-2	15323-2	B1114	B1073	B1079	B1100	B1108	B2762	B2772	B4131	B4371
3	17841-3	15323-3	B1115	B1074	B1080	B1101	B1109	B2763	B2773	B4132	B4372
4	17841-4	15323-4	B1116	B1075	B1081	B1102	B1110	B2764	B2774	B4133	B4373
5	17841-5	15323-5	B1117	B1076	B1082	B1103	B1111	B2765	B2775	B4134	B4374



FLOW	QJB	QSA	QSB	QMB	QQB
3/0	QJB-3/0	QSA-3/0	QSB-3/0	QMB-3/0	QQB-3/0
00	QJB-00	QSA-00	QSB-00	QMB-00	QQB-00
0	QJB-0	QSA-0	QSB-0	QMB-0	QQB-0
1	QJB-1	QSA-1	QSB-1	QMB-1	QQB-1
2	QJB-2	QSA-2	QSB-2	QMB-2	QQB-2
3	QJB-3	QSA-3	QSB-3	QMB-3	QQB-3
4	QJB-4	QSA-4	QSB-4	QMB-4	QQB-4
5	QJB-5	QSA-5	QSB-5	QMB-5	QQB-5

Important Info

- ↓ Direction of flow runs from top to bottom
- + 5/0 is slowest rate (greatest choking effect)
- + 5 is highest (least choking effect)

Notes

- Note 1: 5/16-24 for Bijur tapped holes only
- Note 2: 5/16-24 for 5/32" tubing connections
- Note 3: 5/16-24 for 3/32" tubing connections
- Note 4: 1/4-28 for 3/32" tubing connections
- Note 5: 1/8 NPT
- Note 6: 1/8 BSPT
- Note 7: M8x1 for 5/32" (4mm) tubing connections
- Note 8: M8x1 for tapped holes
- Note 10: Push-to-connect for 5/32" (4mm) tubing connections

Control Units



FLOW	CSA	CSB	CJB	CJC	CJD	CKA	CKB	CKD	CKE	CRA	CRC	CF
5/0	B7022	B8700	B7034	B7148	B7164	B7122	B7133	26413-5/0	B9422	B7142	B7154	--
4/0	B7023	B8701	B7035	B7149	B7165	B7123	B7134	26413-4/0	B9423	B7143	B7155	--
3/0	B7024	B8702	B7036	B7150	B7166	B7124	B7135	26413-3/0	B9424	B7144	B7156	--
00	B7025	B8703	B7037	B7151	B7167	B7125	B7136	26413-00	B9425	B7145	B7157	--
0	B7026	B8179	B7038	B7152	B7168	B7126	B7137	26413-0	B9426	B7146	B7158	--
1	B7027	B8704	B7039	B7153	B7169	B7127	B7138	26413-1	B9427	B7147	B7159	--
2	B6757	B8705	B6817	B6930	B7170	B7128	B7139	26413-2	B9428	B7059	B7160	--
3	B6758	B8706	B6818	B6931	B7171	B7129	B6720	26413-3	B9429	B7060	B7161	B6528
4	B6759	B8707	B6819	B6932	B7172	B7130	B7140	26413-4	B9430	B7061	B7162	B6557
5	B6760	B8177	B6820	B6933	B7173	B7131	B7141	26413-5	B9431	B7062	B7163	B6584



FLOW	CB	CT	CTA	CTB	CTC	CTD	CTG	CTH	CTK	CTL
5/0	B8708	B7028	B7174	B7192	B7186	B7180	B7212	B7218	B7202	B7228
4/0	B8709	B7029	B7175	B7193	B7187	B7181	B7213	B7219	B7203	B7229
3/0	B8710	B7030	B7176	B7194	B7188	B7182	B7214	B7220	B7204	B7230
00	B8711	B7031	B7177	B7195	B7189	B7183	B7215	B7221	B7205	B7231
0	B8712	B7032	B7178	B7196	B7190	B7184	B7216	B7222	B7206	B7232
1	--	B7033	B7179	B7197	B7191	B7185	B7217	B7223	B7207	B7233
2	B8374	B6764	B6775	B7198	B6779	B6783	B6787	B7224	B7208	B7234
3	--	B6765	B6776	B7199	B6780	B6784	B6788	B7225	B7209	B7235
4	--	B6766	B6777	B7200	B6781	B6785	B6789	B7226	B7210	B7236
5	B8716	B6767	B6778	B7201	B6782	B6786	B6790	B7227	B7211	B7237

Important Info

- ↓ Direction of flow runs from top to bottom
- + 5/0 is slowest rate (greatest choking effect)
- + 5 is highest (least choking effect)









Notes

- Note 1: 5/16-24 for Bijur tapped holes only
- Note 2: 5/16-24 for 5/32" tubing connections
- Note 3: 5/16-24 for 3/32" tubing connections
- Note 4: 1/4-28 for 3/32" tubing connections
- Note 5: 1/8 NPT
- Note 6: 1/8 BSPT
- Note 9: 1/8 BSPP





Junctions





Junction Headers





For 5/32 O.D. tubing. Use FT or CT resistance fittings.

5/16-24 Thread (1 Side - 1/8 NPT)	
Description	Part #
 Header 3-Way (TA)	B1503
 Header 3-Way (TC)	B1538
 Header 3-Way (TD)	B1539
 Header 4-Way (TG)	B3150
 Header 4-Way (TB)	B1504
 Header 4-Way (TK)	B4047
 Header 5-Way (TH)	B2810
 Header 5-Way (TL)	B4367

Junctions

1/8 NPT Pipe Thread (All holes have 1/8 pipe thread.)				
Description	A(in)	B(in)	C(in)	Part #
 3-Way	7/8	--	7/16	B7682
 3-Way	7/8	--	5/16	B7683
 4-Way	1-1/8	--	9/16	B7684
 5-Way	7/8	--	7/16	B7686

 2-Way (w/ mount hole)	7/8	--	7/16	B7690
 2-Way (w/ mount hole)	7/8	--	7/16	B7691
 3-Way (w/ mount hole)	7/8	--	7/16	B7692
 3-Way (w/ mount hole)	7/8	--	7/16	B7693
 4-Way (w/ mount hole)	1-1/4	--	7/16	B7694

5/16-24 Thread (5/32" Tube)				
Description	A(in)	B(in)	C(in)	Part #
 2-Way (w/ mount hole)	1-1/8	--	9/16	B3288
 2-Way	13/16	--	9/16	B5149
 3-Way	1-1/8	--	1/4	B3065
 3-Way	1/8	--	9/16	B1092
 4-Way	1-1/8	--	1/4	B4231

R1/8 BSPT Outlets				
Description	A(mm)	B(mm)	C(mm)	Part #
 3-Way (tee)	22	--	11.1	17186



M8x1 Thread (4mm Tube)				
Description	A(mm)	B(mm)	C(mm)	Part #
 2-Way	28.6	--	14.3	17840
 3-Way	28.6	--	14.3	22564

Figure 1:
Single Outlet (2 Mounting Holes)

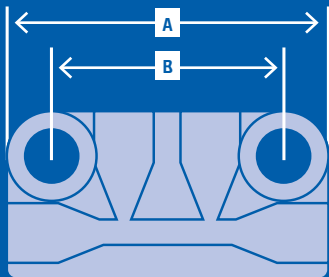

Figure 2:
Single Outlet (1 Mounting Holes)

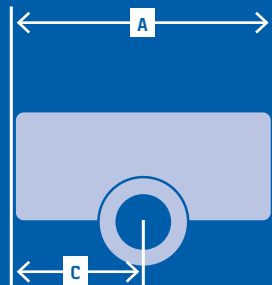
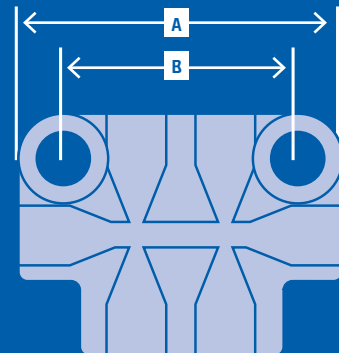









Figure 3:
Double Outlet (2 Mounting Holes)





Note:





Additional junction sizes are available upon request. See [Datasheet #35469: Junctions, Junction Bars and Headers](#) for more detailed specifications.

Junction Bars – Single Side Outlet

1/8 NPT Pipe Thread (All holes have 1/8 pipe thread. Aluminum bar stock.)				
Description	A(in)	B(in)	C(in)	Part #
 4-Way	2-1/4	1-3/4	--	B7687
 5-Way	3-1/8	2-5/8	--	B7688
"" 6-Way	4	3-1/2	--	B7689
"" 7-Way	4-7/8	4-3/8	--	B8897
"" 8-Way	5-3/4	5-1/4	--	B8898
"" 10-Way	7-1/2	7	--	B8899
5/16-24 Thread (Use FJB or CJB resistance fittings.)				
Description	A(mm)	B(mm)	C(mm)	Part #
 4-Way	48	36	--	B3262
 5-Way	64	52	--	B3263
"" 6-Way	80	68	--	B3264
"" 7-Way	96	84	--	B3289
"" 8-Way	112	100	--	B3265
"" 9-Way	128	116	--	B4508
"" 10-Way	144	132	--	B3704
"" 12-Way	176	164	--	B3471
5/16-24 Thread (Use FJC or FJD resistance fittings.)				
Description	A(in)	B(in)	C(in)	Part #
 2-Way	15/16	--	15/32	B4522
 3-Way	1-1/8	11/16	--	B4498
 4-Way	1-9/16	1-1/8	--	B3764
 5-Way	2	1-9/16	--	B3765
"" 6-Way	2-7/16	2	--	B3766
"" 7-Way	2-7/8	2-7/16	--	B3767
"" 8-Way	3-5/16	2-7/8	--	B3768
"" 9-Way	3-3/4	3-3/16	--	B3769
"" 10-Way	4-3/16	3-1/4	--	B3770

"" 11-Way	4-5/8	4-3/16	--	B3771
"" 12-Way	5-1/16	4-5/8	--	B3772
R1/8 BSPT Inlets – M10x1 Outlets				
Description	A(mm)	B(mm)	C(mm)	Part #
 7-Way	96	86	--	17881
M8x1 Thread				
Description	A(mm)	B(mm)	C(mm)	Part #
 4-Way	48	36	--	20348-4
"" 5-Way	64	52	--	20348-5
"" 6-Way	80	68	--	20348-6
"" 7-Way	96	84	--	20348-7
"" 8-Way	112	100	--	20348-8
"" 10-Way	144	132	--	20348-10

Junction Bars – Double Outlet

5/16-24 Thread (Use FJB or CJB resistance fittings or compression fittings.)			
Description	A(in)	B(in)	Part #
 6-Way	1-13/16	1-5/16	B3109
 8-Way	2-7/16	1-15/16	B3253
"" 10-Way	3-1/16	2-9/16	B3254
"" 12-Way	3-11/16	3-3/16	B3249
"" 14-Way	4-3/16	3-13/16	B4020
"" 16-Way	4-15/16	4-7/16	B4025
5/16-24 Thread			
Description	A(in)	B(in)	Part #
 6-Way	1-9/16	1-1/8	B3785
 8-Way	2	1-9/16	B3786
"" 10-Way	2-7/16	2	B3787
"" 12-Way	2-7/8	2-7/16	B3788
"" 14-Way	3-3/16	2-7/8	B3789

Fittings & Spare Parts

Lubricator Fittings

Compression Fittings

The SureFire SLR centralized lubrication system also features many compression fittings and accessories that let you maximize the effectiveness of the system. From straight connectors to bushings, these options also meet the highest Bijur Delimon manufacturing standards. If compression is your fitting of choice, just choose the appropriate part number from the chart.

Push-to-connect Fittings

When you need to install or change a piece of tubing, push-to-connect fittings let you do it quickly and easily. Push-to-connect fittings let you remove tubing with a simple click. Then, just push the new tubing into the fitting. The new tubing stays securely in the fitting.

Part Numbers

Description		Compression Fittings	Push-to-connect Fittings
Lubricator outlet fittings (G1/4 BSPP Male)	6mm tubing, straight (G1/4)	AR397	
	6mm tubing, elbow (R1/4)	AR961	
	6mm tubing, banjo	AR1032	
	1/4" O.D. tubing, straight	B10176-4C	
	5/16" O.D. tubing, straight	B10176-5	
	1/8" NPTF, straight	B10279-7C	
	6mm tubing, straight		AR1983
	6mm tubing, swivel elbow		AR2089
Copper washer	M8	20913-9	
	1/4 BSPP	35010	
Tee fittings	6x6x6 for main line	35004	AR2134
Union	6x6		AR2061

Technical Data

Description	Compression Fittings	Push-to-connect Fittings ¹
Maximum operating pressure	207 bar (3000 psi) at 20°C (68°F)	24 bar (350 psi) at 20°C (68°F)
Seals	Metal	Viton
Recommended tubing	Metal or Nylon	Nylon

¹ Push-to-connect fittings are supplied with tubing support inserts. They must be used to achieve the rated maximum pressure.











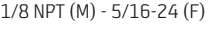
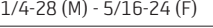

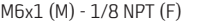
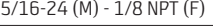







COMPRESSION FITTINGS

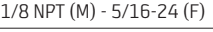
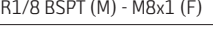
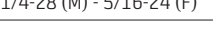

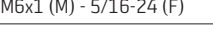
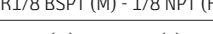
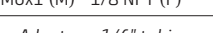
PUSH-TO-CONNECT FITTINGS







Specialty Fittings



Adapters	Part #
<i>Straight Adapters, 4mm (5/32") tubing</i>	
 1/8 NPT (M) - 5/16-24 (F)	A2835
 1/4-28 (M) - 5/16-24 (F)	B4312
 R1/8 BSPT (M) - 5/16-24 (F)	B8884
 M6x1 (M) - 1/8 NPT (F)	B8511-1
 5/16-24 (M) - 1/8 NPT (F)	B6056
 1/8 NPT (M) - 5/16-24 (F)	B2253
 5/16-24 (M) - 1/8 NPT (F)	B5560
<i>Straight Adapters, 3/32" tubing</i>	
 1/8 NPT (M) - 5/16-24 (F)	B3430
 1/4-28 (M) - 5/16-24 (F)	B4316
 1/4-28 (M) - 1/4-28 (M)	B4452
<i>Straight Adapters, 1/4" tubing</i>	
 1/8 NPT (M) - 7/16-24 (M)	B6086
 1/8 NPT (M)	B6534
<i>Thru Adapters, 4mm (5/32") tubing</i>	
 1/8 NPT (M) - 5/16-24 (F)	B3488
<i>Tee Adapters, 4mm (5/32") tubing</i>	
 1/8 NPT (F) - 5/16-24 (F)	A4042
<i>90° Elbow Adapters, 4mm (5/32") tubing</i>	
 1/8 NPT (M) - 5/16-24 (F)	A3080
 R1/8 BSPT (M) - M8x1 (F)	19199
 1/4-28 (M) - 5/16-24 (F)	19285
 R1/8 BSPT (M) - 5/16-24 (F)	B8883
 M6x1 (M) - 5/16-24 (F)	21238
 R1/8 BSPT (M) - 1/8 NPT (F)	19833
 M6x1 (M) - 1/8 NPT (F)	B8516-1
<i>90° Elbow Adapters, 1/4" tubing</i>	
 1/8 NPT (M)	B6536
Connectors	Part #
<i>Straight Connectors</i>	
 1/8 NPT (M) - 1/8 NPT (F)	A3920
 1/4-28 (M) - 1/8 NPT (F)	B4311
 1/8 NPT (F) - 1/8 NPT (M)	B6539
 1/8 NPT (M) - 1/8 NPT (M)	A4019

Spare Parts

SureFire SLR model number	SF2Axxx	SF3Axxx	SF6Axxx	SF12Axxx
Part Description	Part #	Part #	Part #	Part #
Reservoir assembly - Standard Terlux ABS ⁴	34794 ¹	34795 ¹	34796 ¹	N/A
Reservoir assembly - Alternate Polycarbonate	34794-1 ¹	34795-1 ¹	34796-1 ¹	N/A
Reservoir assembly - Alternate Metal	N/A	60281 ¹	N/A	35153 ²
Reservoir inlet strainer assembly (w/ screws)	35150	35150	35150	35150
Automotive quick connector assy., for grease applications (w/ O-ring)	35151	35151	35151	35151
Automotive quick connector assy., for oil applications (w/ O-ring)	35152	35152	35152	35152
Motor cover, O-ring, screw	34791	34792	34793	34793
Level switch (std. for oil versions), Level switch stem (single-phase)	34797	34797	34798	34798
Level switch for oil (three phase)	N/A	AC368-4	AC368-3	AC368
2 position level switch for oil	39161-4793-1	39161-4793-1	39161-4793-2	39161-4793-2
Level switch for grease ⁵	23470	23470	23470	23470
Pressure gauge (single phase)	23522	23522	23522	23522
Pressure gauge (three phase)	23572	23572	23572	23572
Pressure switch (normally open, closes at 1.4 ±0.3 bar [20 ±5 psi]) ³	23545	23545	23545	23545
On-off timer (optional)	35074	35074	35074	35074
Motor (24 VDC)	27632	27632	27632	27632
Motor (115/230 VAC), Motor fan	34876	34876	34876	34876
Motor (100/200 VAC)	23970	23970	23970	23970
Motor (230/480 VAC three phase), Mounting screws	23233	23233	23233	23233
Gear Pump (20-1500 cp)	25937-1	25937-1	25937-1	25937-1
Electrical connector fitting	34681	34681	34681	34681

¹ O-ring, clasp, clasp plate and clasp plate screws
² Assembly, gasket bolts and washers
³ Comes standard on SLR controller models
⁴ Surefire is shipped with a Terlux plastic reservoirs as standard (1.8-6 liter), metal is standard on 12 liter.
⁵ Support Rod is p.n. 35110

<i>Elbow Connectors</i>		
	1/8 NPT (M) - 1/8 NPT (F)	A2768
	1/4-28 (M) - 1/8 NPT (F)	B3608
	1/8 NPT (M) - 1/8 NPT (F)	B3133
<i>Tee Connectors</i>		
	1/8 NPT (M) - 1/8 NPT (F)	B4390

<i>Couplings, 4mm (5/32") tubing</i>		Part #
	5/16-24 (F) - 5/16-24 (F)	A2899
	5/16-24 (M) - 1/8 NPT (F)	B3108

Note: Additional English & metric threads are available.

Tubing & Accessories

Tubing

Copper Tubing (O.D.)	Wall	Part #
3/32"	.022"	3C22
5/32" (4mm)	.025"	5C25
5/32" (4mm)	.055"	5C55
1/4"	.030"	8C30
6mm	1mm	21431-6
Nylon Tubing (O.D.)	Wall	Part #
3/32"	.020"	3N20
5/32" (4mm)	.025"	5N25
5/32" (4mm)	.055"	5N55
4mm	.5mm	73100-2114
1/4"	.030"	8N30
1/4"	.050"	21672
5/16"	.040"	20100
Spring Cover (O.D.)	Wall	Part #
5/32" (4mm)	--	20111
1/4"	--	20844
Steel Tubing (O.D.)	Wall	Part #
3/32"	.020"	3S20
5/32" (4mm)	.020"	5S20
1/4"	.028"	8S28

Brass Tubing (O.D.)	Wall	Part #
5/32" (4mm)	.025"	5B25
Black Nylon Tubing (O.D.)	Wall	Part #
5/32" (4mm)	.025"	19230
5/32" (4mm)	.055"	5N55B
1/4" (high pressure)	.062"	810437
5/16"	.040"	19159

Tubing Clips

Tubing Clips	# of Tubes	Qty	Part #
3/32"	1	25	34486
5/32" (23/32 lg)	1	25	34487
5/32" (7/8 lg)	1	25	34488
5/32"	2	25	34489
5/32"	2	25	34490
5/32"	3-5	25	34491
1/4"	1	25	34492
5-7mm	1	25	34499
7-9mm	1	25	35377
7-9mm (2 mount holes)	1	10	34758
3/8"	1	25	34493

Note: All tubing clips have 1 mounting hole unless otherwise noted.

TUBING



TUBING CLIPS

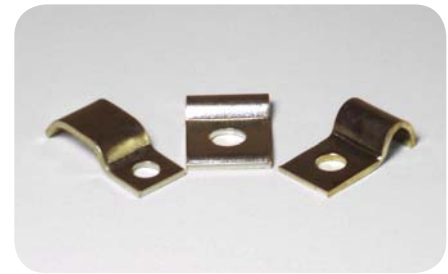

Tubing Connections

Use Figure 1 and the chart below to determine the connections for your tubing type.

Tube Size (O.D.)	Qty	5/32" (4mm)						3/32"		
		5/16-24 (M)			5/16-24 (F)			5/16-24 (M)		5/16-24 (F)
Fitting Size		Metal	Metal	Nylon	Metal	Nylon	Metal	Nylon	Metal & Nylon	Metal & Nylon
Compression Bushing	25	BB1371	--	--	34494	34494	--	--	BB3373	--
Compression Nut	25	--	BB1095	BB1095	--	--	34495	34495	--	BB3312
Compression Sleeve	50	BB1061	BB1061	BB8272	BB1061	BB8272	BB1061	BB8272	BB3313	BB3313
Closure Plug	10	34496	--	--	34497	34497	--	--	34496	--

Figure 1: Tubing Diagram

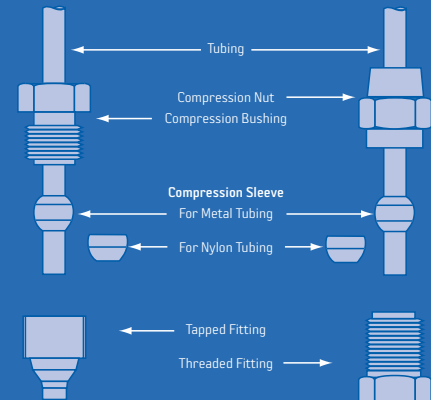

Flexible Hose

Hoses are used as a means of extending the oil lines to individual bearings or machine units having relative motion to the frame of a machine. The assemblies consist of synthetic oil resisting hose fastened to suitable terminals. They can be supplied in a variety of lengths, in the following types:

- + **Type SS** has a tube terminal at each end to connect directly to meter units, junctions, etc.
- + **Type SC** has a tube terminal at one end and a threaded terminal at the other end for a 5/32" O.D. tubing connection and bracket support.
- + **Type CC** has a threaded terminal at each end for 5/32" O.D. tubing connection and bracket support.
- + **Type SSS** is the same as Type SS, with a wire wrap for a 5/16" O.D. tubing connection.
- + **Type SSA** is the same as Type SS, with a mesh wrap for a 3/8" O.D. tubing connection.

Brackets and terminal nut for types SC and CC are shown below and should be ordered separately.

TYPE SS (5/16" O.D.)

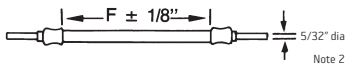

TYPE SS (7/16" O.D.)

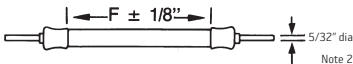

TYPE SC (7/16" O.D.)

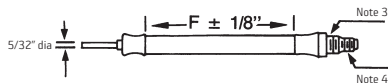

TYPE CC (7/16" O.D.)

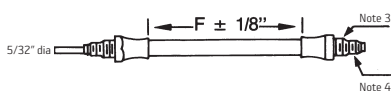

TYPE SSS (5/16" O.D.)

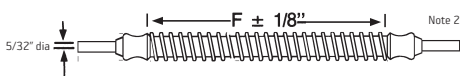

TYPE SSA (3/8" O.D.)

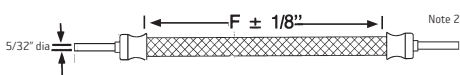

Length "F"	Part #					
	SS 5/16" O.D.	SS 7/16" O.D.	SC 7/16" O.D.	CC 7/16" O.D.	SSS 5/16" O.D.	SSA 3/8" O.D.
4"	B4514	—	—	—	—	—
5"	B4515	B2962	B4857	B4873	20106-4	19006-5
6"	B4516	B3134	B4858	B4874	20106-6	--
7"	B4517	B2963	B4859	B4875	20106-7	19006-7
8"	B4518	B3433	B4860	B4876	20106-8	--
9"	B4519	B2542	B4861	--	20106-9	--
10"	B4520	B3145	B4862	B4878	20106-10	B06-10
12"	B4588	B3135	B4863	B4879	20106-12	19006-12
14"	B4589	B3530	B4864	B4880	20106-14	B06-14
16"	B6415	B3531	B4865	B4881	20106-16	B06-16
18"	B6416	B3137	B4866	B4882	20106-18	B06-18
20"	--	B3532	B4867	B4883	20106-20	B06-20
21"	B01-21	B3507	--	--	20106-21	--
22"	B01-22	B3528	B4868	B4884	20106-22	B06-22
24"	B8077	B3508	B4869	B4885	20106-24	B06-24
27"	B01-27	B3533	B4870	B4886	20106-27	--
28"	B01-28	B02-28	--	--	20106-28	--
30"	B01-30	B3534	B4871	B4887	--	B06-30
32"	--	B02-32	--	--	--	19006-32
33"	B01-33	B3735	B4872	B4888	20106-33	--
35"	--	19002-35	--	--	20106-35	--
36"	B01-36	B4780	--	B04-36	20106-36	B06-36
38"	B01-38	B02-38	--	--	--	B06-38
40"	B01-40	B4235	B03-40	--	20106-40	19006-40
42"	--	B02-42	--	--	--	--
44"	--	B4796	--	--	20106-44	--
46"	B01-46	B8786	--	--	--	--
48"	B01-48	B4980	B5819	B6317	20106-48	B06-48
52"	--	B4418	--	--	--	--
53"	B01-53	--	--	--	--	--
56"	--	B4011	--	B04-56	20106-56	--
60"	B01-60	B4740	B03-60	--	20106-60	--
66"	--	B4795	--	--	--	--
72"	B01-72	B4994	--	B6318	20106-72	B06-72
84"	B01-84	B6320	--	--	20106-84	--

Note 1: Above hoses are also available in special lengths.

Note 2: Use compression fittings.

Note 3: 3/8-24 thread for bracket mounting.

Note 4: 5/16-24 thread for 5/32" O.D. tubing connection. Use compression nut #B1095 and compression sleeve #B1061.

Note: Hoses, when installed on a machine, should take care of the motion by a bending action of the hose. Twisting should be avoided as much as possible. Do not bend terminal tubes or leave a permanent twist in the hose when installing.

Dimensional Schematics

Note: All dimensions shown in millimeters.

SureFire SLR 1.8, 2.7 & 6.0 Liter 115 VAC, 230 VAC and 24 VDC Single Phase

Left View

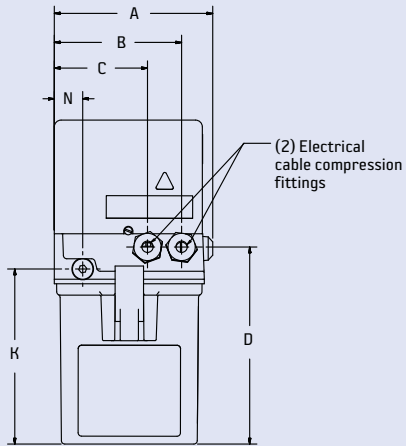

Front View

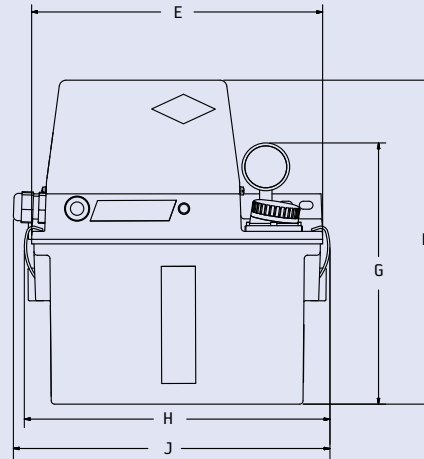

Right View

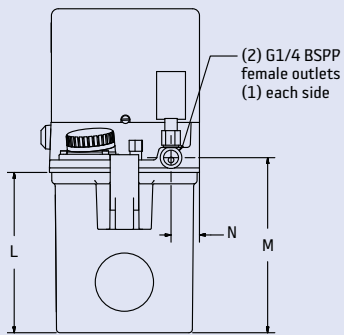

Back View

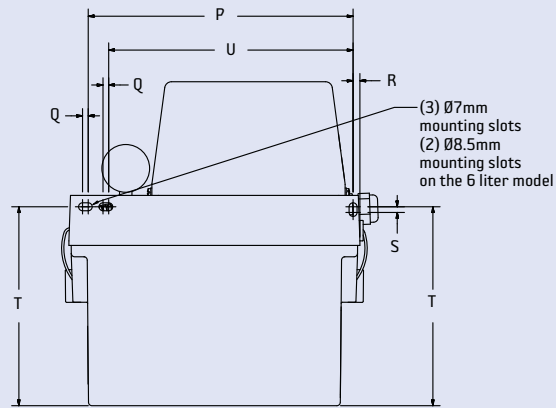

Reference	A	B	C	D	E	F	G	H	J	K	L	M	N	P	Q	R	S	T	U
1.8 liter	136	114	82	174	170	285	230	183	204	154	141	154	25	153	5	6	5	175	N/A
2.7 liter	139	114	82	174	256	285	230	269	279	154	141	154	25	233	5	6	5	175	215
6.0 liter	186	117	85	204	290	318	264	303	N/A	187	174	187	25	220	5	35	5	209	N/A

SureFire SLR 12.0 Liter

115 VAC, 230 VAC and 24 VDC Single Phase

Left View

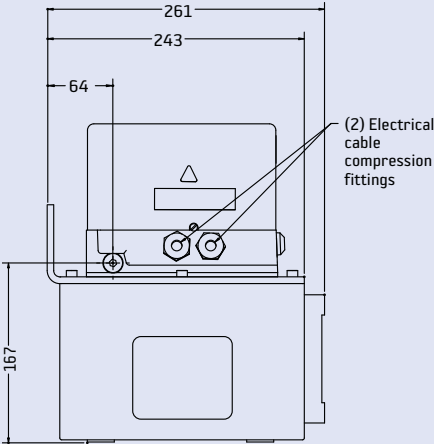

Front View

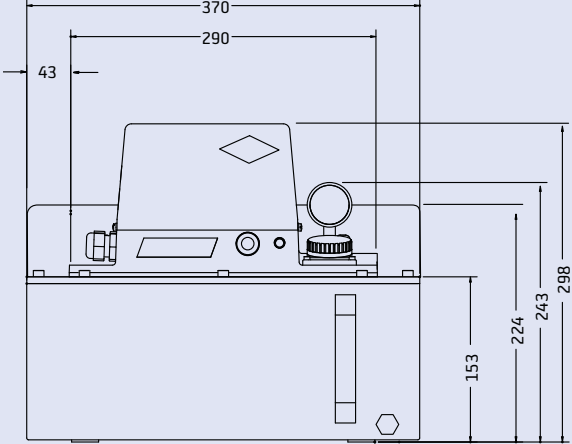

Right View

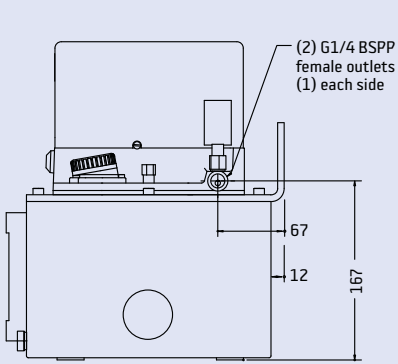

Back View

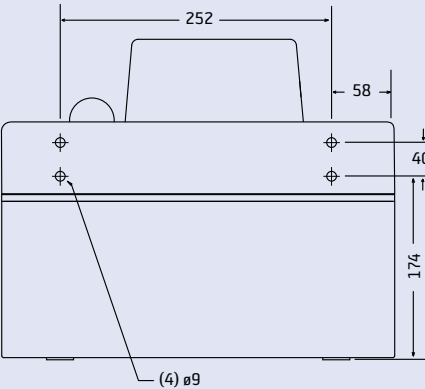

Bottom View

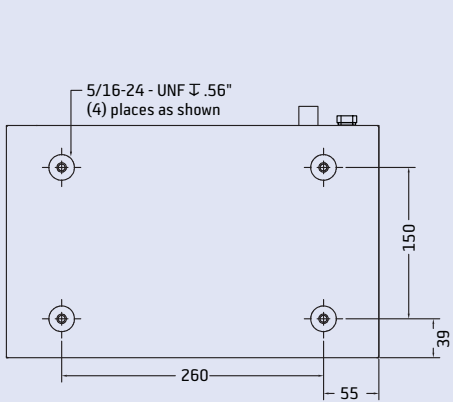

Note: All dimensions shown in millimeters.

SureFire SLR 1.8, 2.7 & 6.0 Liter
 230/480 VAC Three Phase

Left View

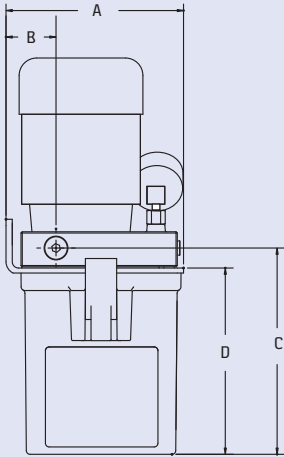

Front View

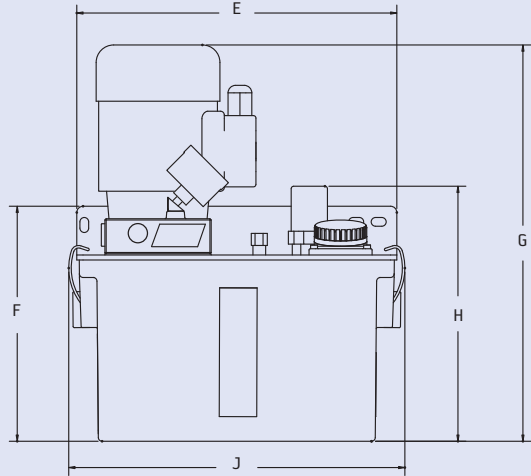

Right View

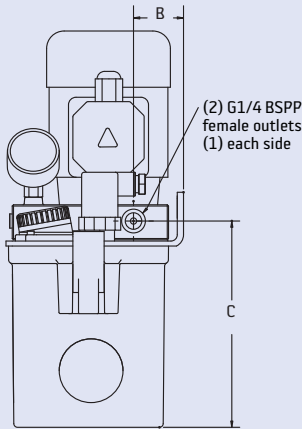

Back View

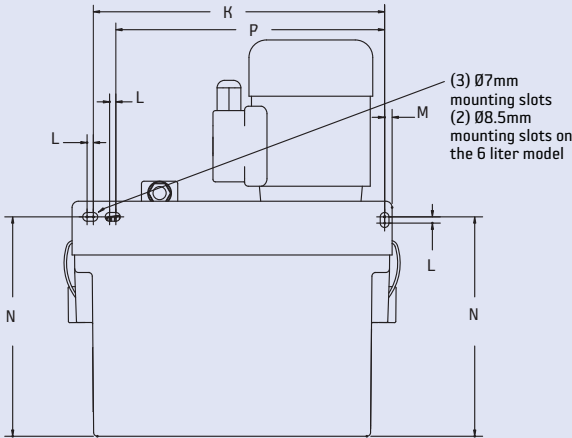

Reference	A	B	C	D	E	F	G	H	J	K	L	M	N	P
1.8 liter	135	36	163	149	170	188	317	202	183	153	5	6	175.5	N/A
2.7 liter	144	45	163	149	256	188	317	202	269	233	5	6	175.5	215
6.0 liter	190	48	196	182	290	221	350	237	303	220	5	35	209	N/A

SureFire SLR 12.0 Liter 230/480 VAC Three Phase

Left View

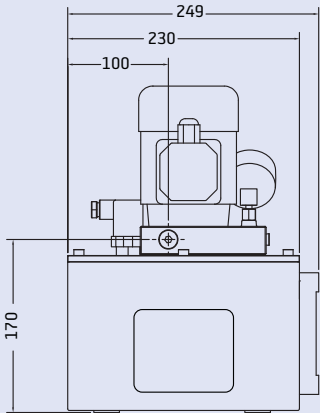

Front View

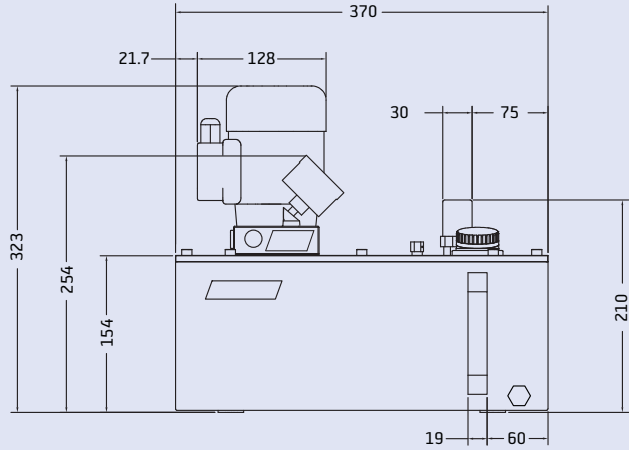

Right View

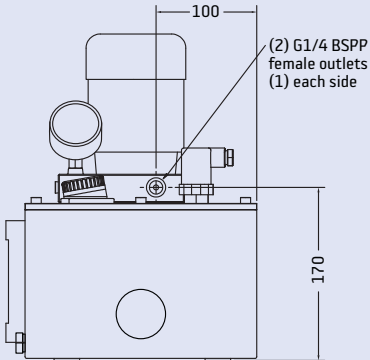

Back View

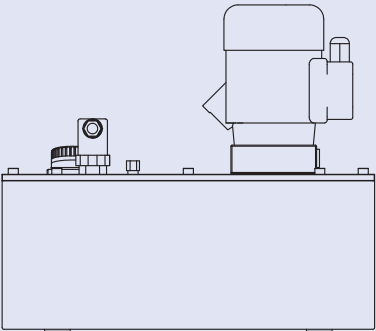

Bottom View

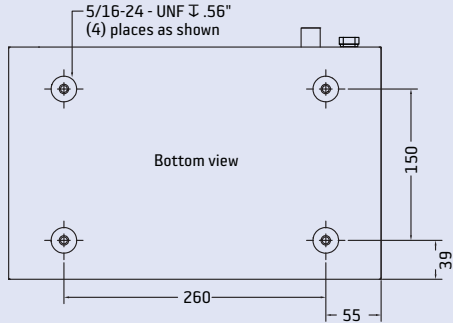

Lined writing area with horizontal rules.

Innovators of engineered lubrication technology **since 1923**

Bijur Delimon International has ISO 9001:2000 and ISO 14000 quality certified manufacturing facilities around the world, so your centralized lubrication system meets the highest industry quality standards. It's all part of our commitment to quality and customer service.



GLOBAL HEADQUARTERS

Bijur Delimon International
2100 Gateway Centre Blvd., Suite 109
Morrisville, NC 27560

(919) 465 4448 **LOCAL**
(800) 631 0168 **TOLL-FREE**
(919) 465 0516 **FAX**

WWW.BIJURDELIMON.COM

B262 • R12 11/13